

9.00 – 9.45 Fisica tecnica del tetto 1
Prestazione invernale ed estiva

30 min Pausa

10.15 – 10.45 Fisica tecnica del tetto 2
Diffusione al vapore e tenuta all'aria

10 min Discussione

....

14.30 – 15.15 **Pacchetti e applicazioni della fisica tecnica**

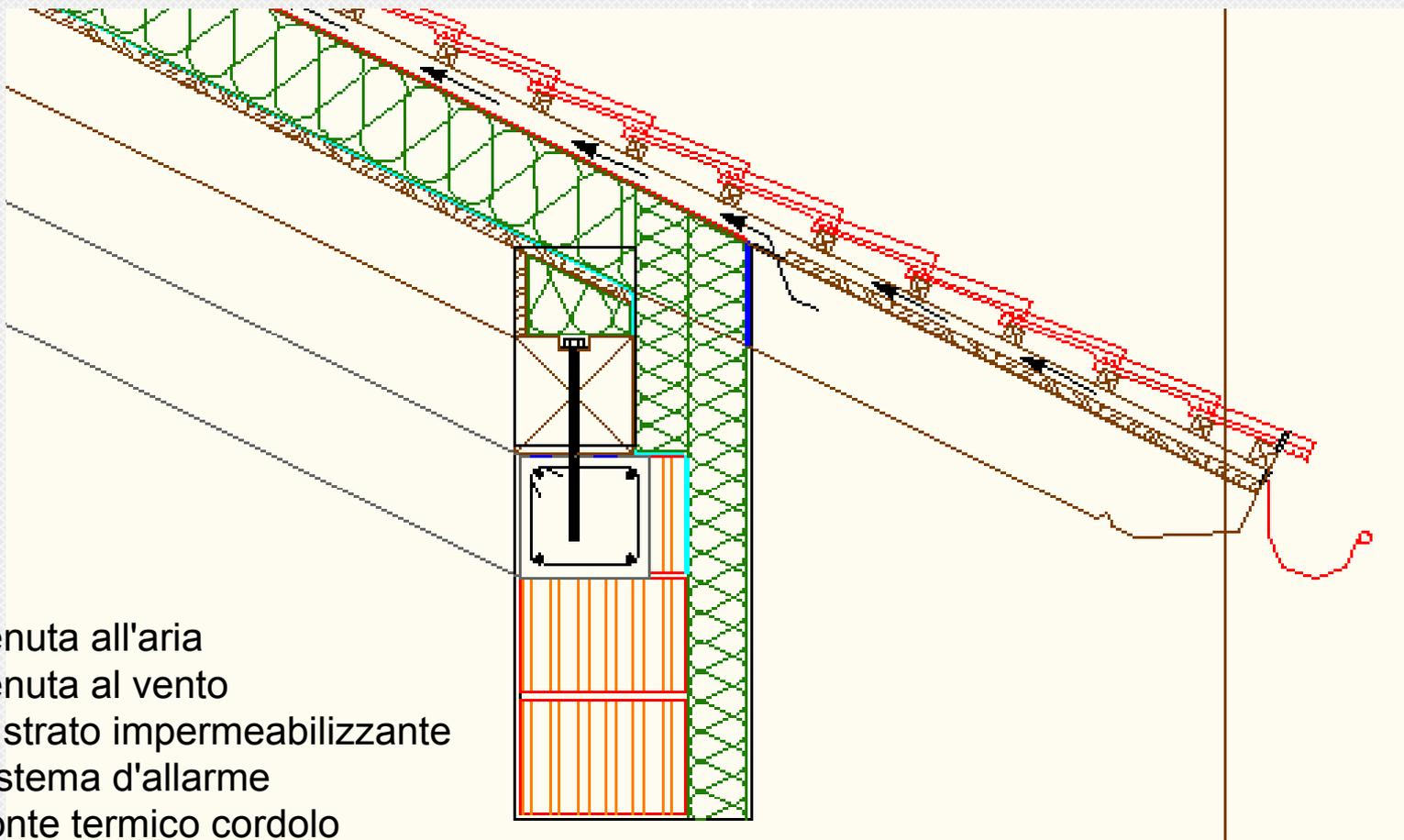

- Tenuta all'aria
- Tenuta al vento
- 2° strato impermeabilizzante sistema d'allarme
- Ponte termico cordolo

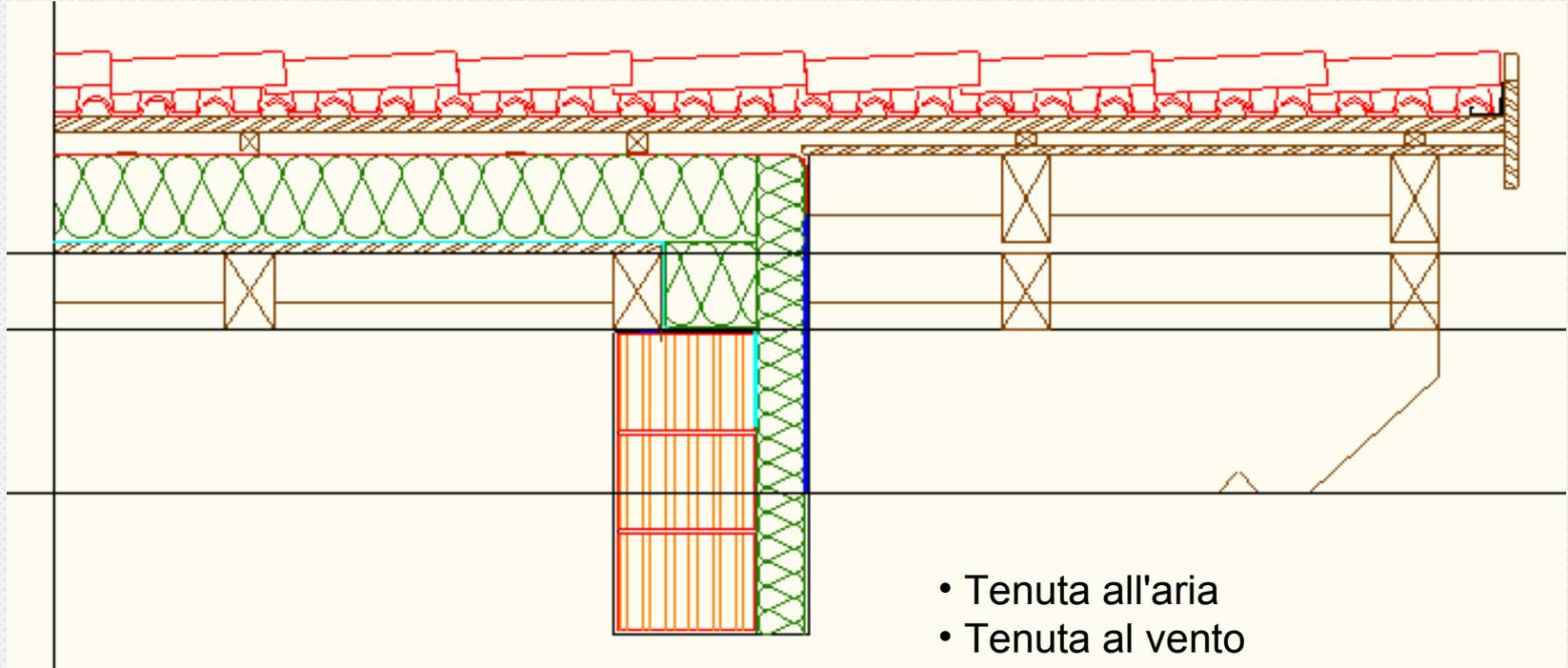

- Tenuta all'aria
- Tenuta al vento
- Ponte termico attacco



Attacco parete - tetto

promo_legno



Attacco parete - tetto

promo_legno





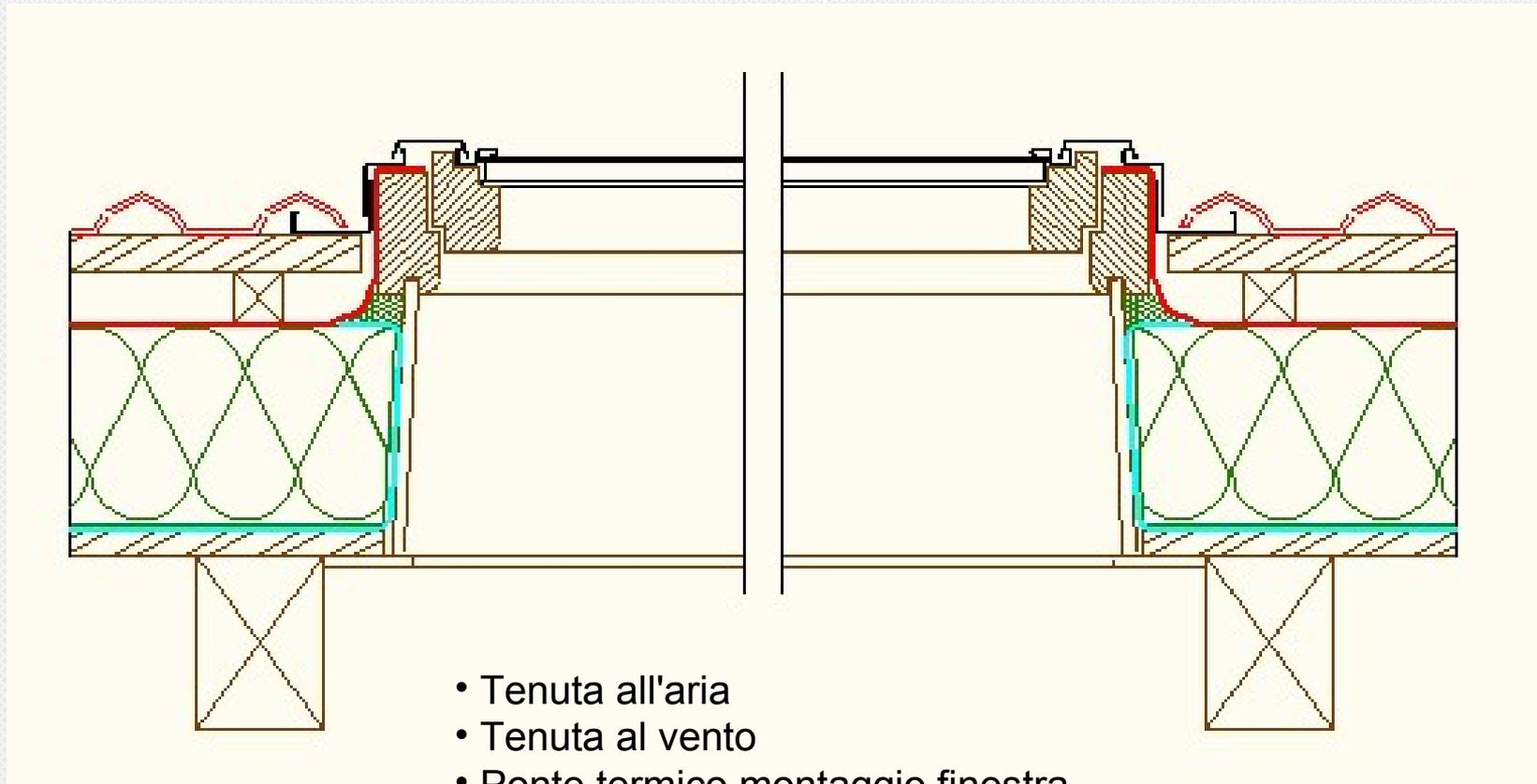

- Tenuta all'aria
- Tenuta al vento
- Ponte termico

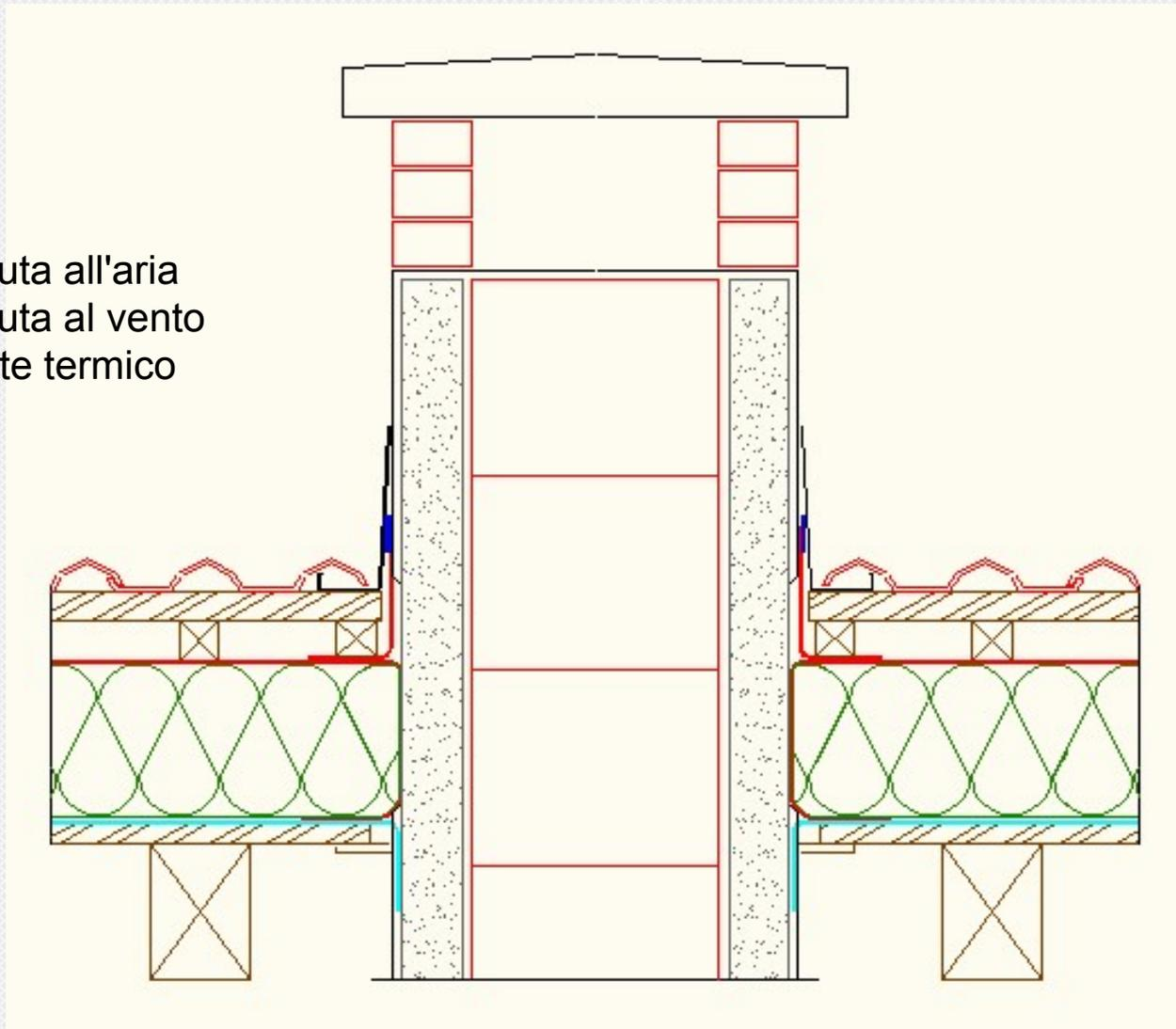

Attacco tubo ventilazione/sfiato

promo_legno

- Tenuta all'aria
- Tenuta al vento
- Ponte termico

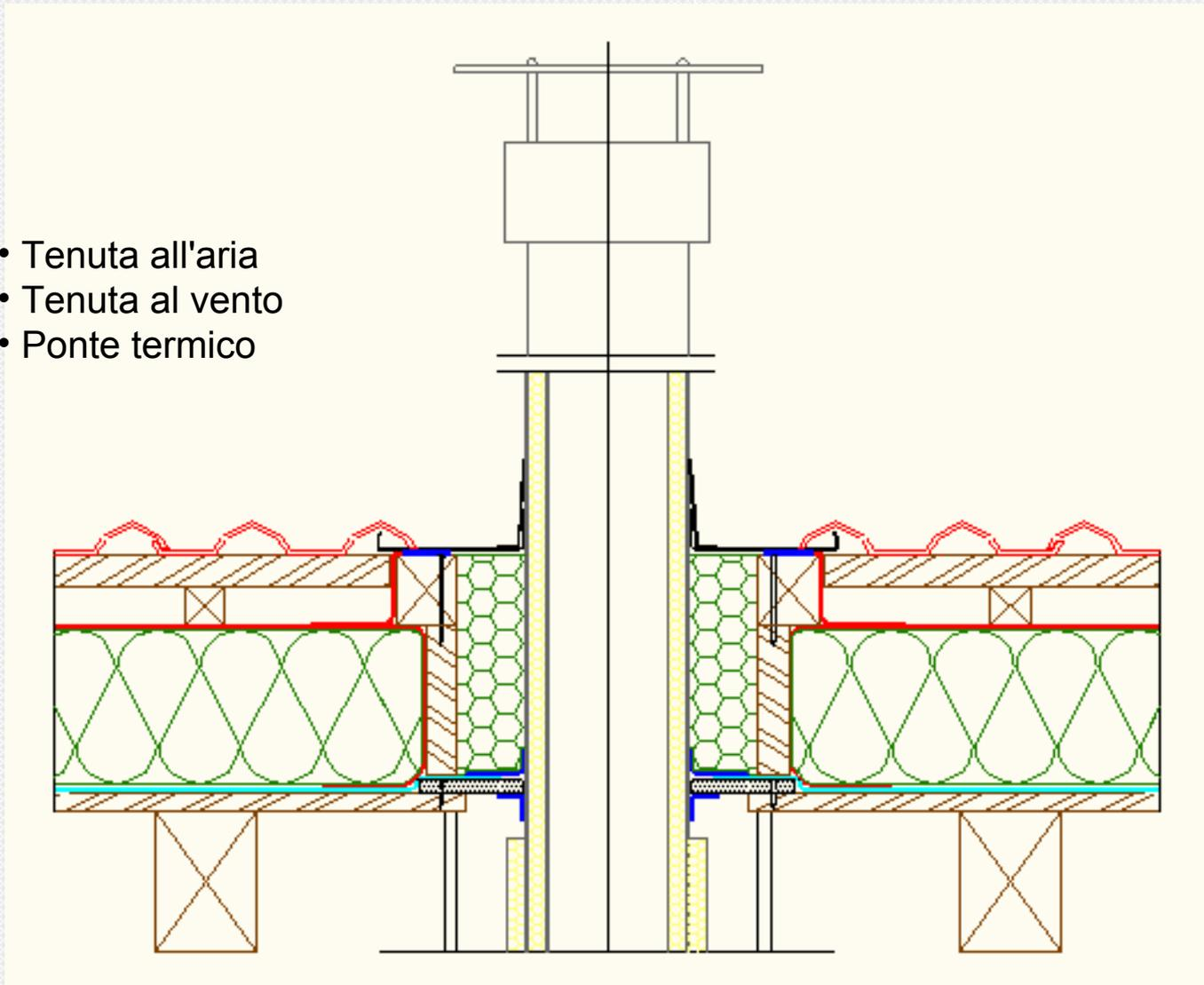



Passaggi camini – tubazioni multipli

promo_legno



- Ventilazione del colmo senza malta

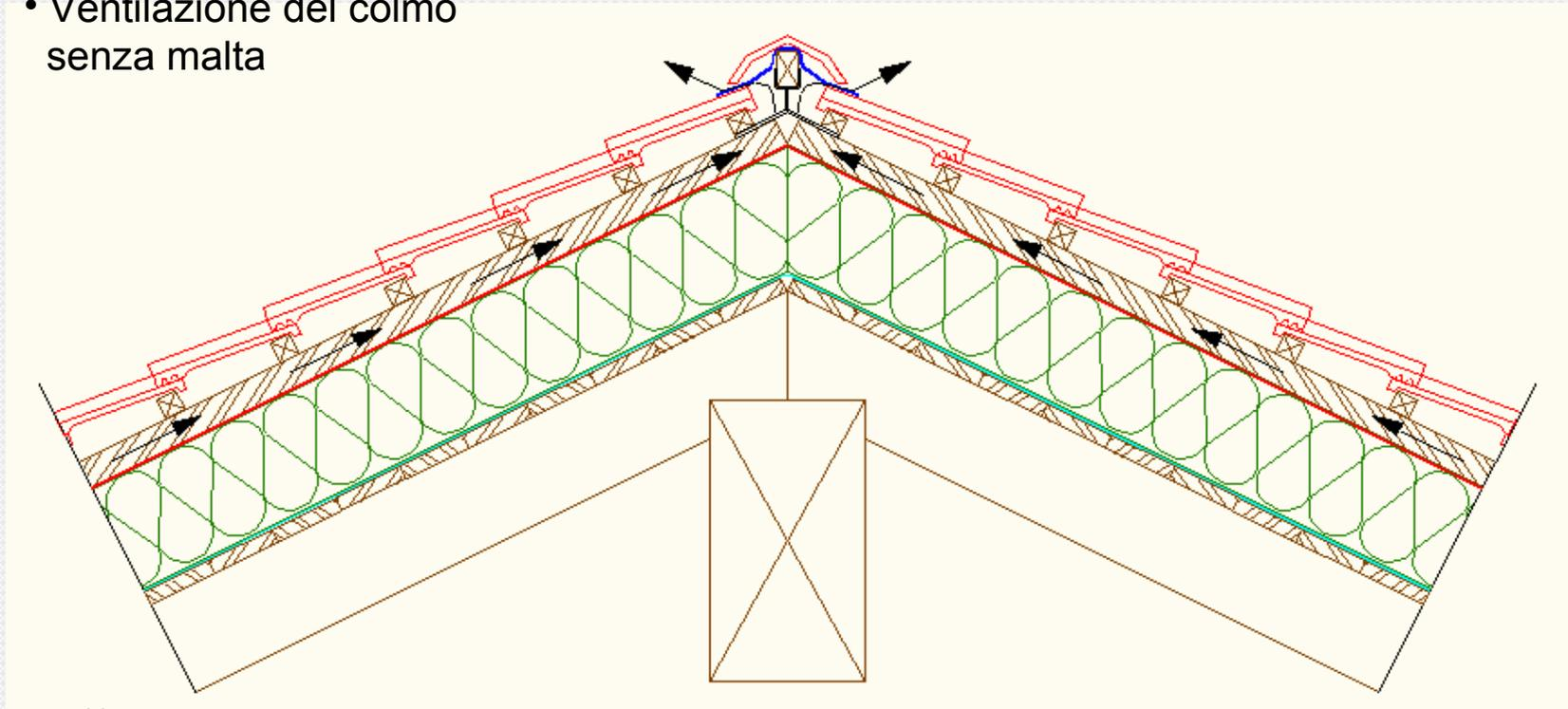

Colmo ventilato

promo_legno

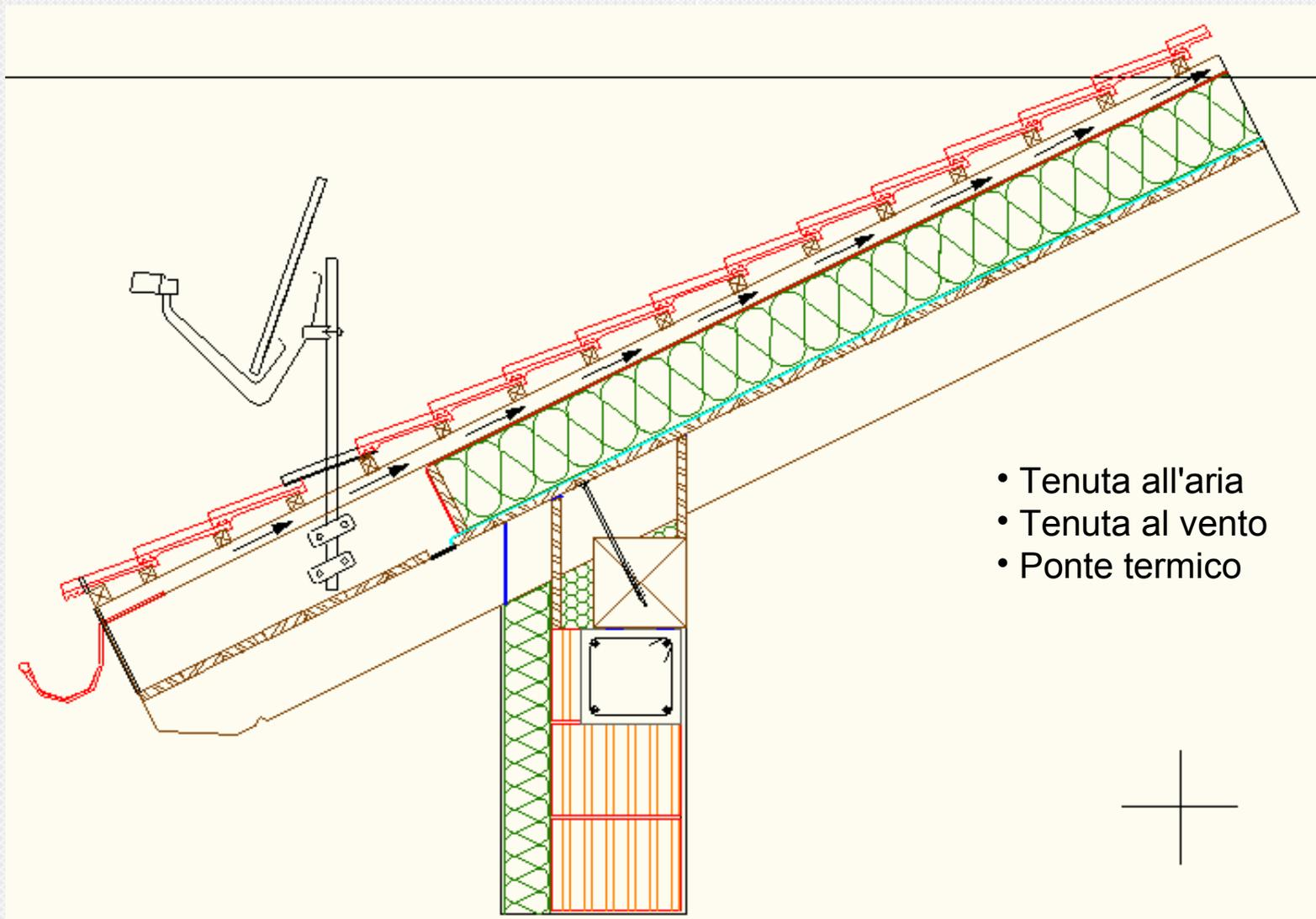

Tipo A 16,0 cm	costo:	178,10 €/ m ²
	senza coibente:	136,93 €/ m ²
	% influenza coibente:	23,12 %

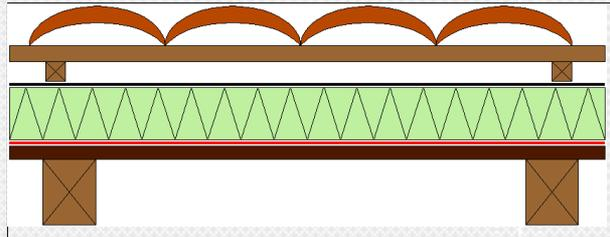

Componenti
Travetti
perline
freno vapore
fibra di legno pesante
telo traspirante
listello ventilazione
listello porta tegola
tegola laterizio
Totali

Tipo B 16,0 cm	costo:	170,40 €/ m ²
	senza coibente:	136,93 €/ m ²
	% influenza coibente:	19,64 %

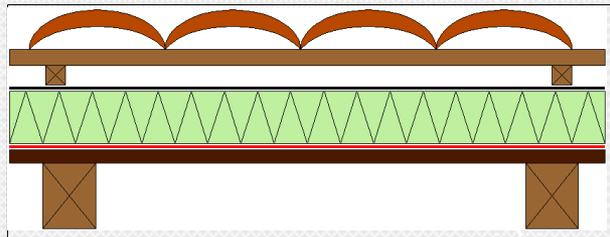

Componenti
Travetti
perline
freno vapore
fibra di legno leggera
telo traspirante
listello ventilazione
listello porta tegola
tegola laterizio
Totali

Tipo C 16,0 cm	costo:	188,41 €/ m ²
	senza coibente:	136,93 €/ m ²
	% influenza coibente:	27,33 %

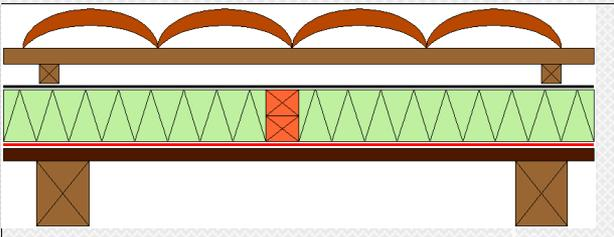

Componenti
Travetti
perline
freno vapore
fibra di legno leggera
listello contenitivo
telo traspirante
listello ventilazione
listello porta tegola
tegola laterizio
Totali

Tipo D 16,0 cm	costo:	196,11 €/ m ²
	senza coibente:	136,93 €/ m ²
	% influenza coibente:	30,18 %

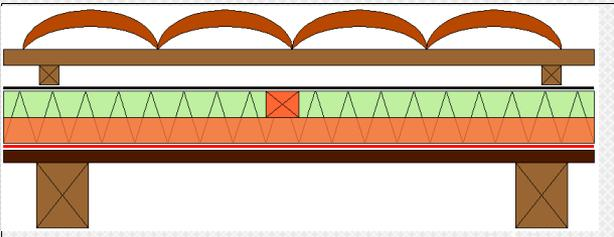

Componenti
Travetti
perline
freno vapore
fibra di legno pesante
listello contenitivo
telo traspirante
listello ventilazione
listello porta tegola
tegola laterizio
Totali

Tipo E	costo:	175,38 €/ m²
6,0 cm	senza coibente:	136,93 €/ m²
10,0 cm	% influenza coibente:	21,93 %

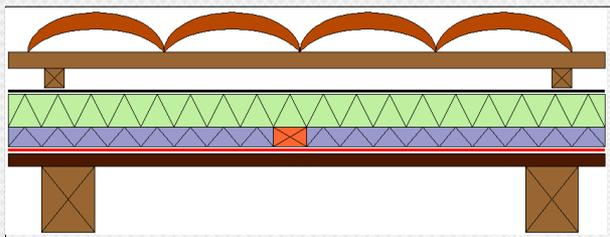

Componenti

Travetti
perline
freno vapore
Polistirol
listello contenitivo
fibra di legno leggera
telo traspirante
listello ventilazione
listello porta tegola
tegola laterizio

Totali

Tipo F	costo:	181,78 €/ m²
16,0 cm	senza coibente:	148,31 €/ m²
	% influenza coibente:	18,41 %

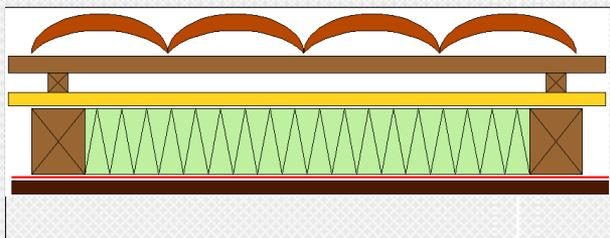

Componenti

perline
freno vapore
Travetti
fibra di legno leggera
DHF
listello ventilazione
listello porta tegola
tegola laterizio

Totali

Tipo G 16,0 cm	costo:	153,04 €/ m ²
	senza coibente:	108,85 €/ m ²
	% influenza coibente:	28,88 %

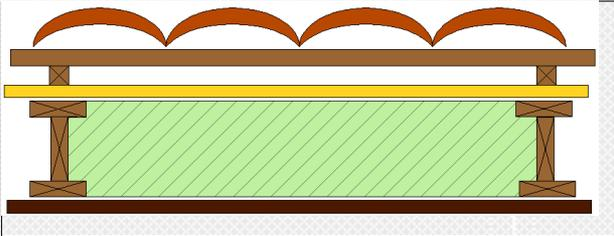

Componenti
OSB
cellulosa
Travetti
DHF
listello ventilazione
listello porta tegola
tegola laterizio
Totali

Tipo H 16,0 cm	costo:	184,89 €/ m ²
	senza coibente:	151,42 €/ m ²
	% influenza coibente:	18,10 %

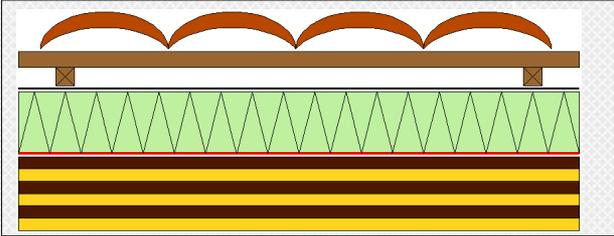

Componenti
10 cm Xlam
freno vapore
fibra di legno leggera
telo traspirante
listello ventilazione
listello porta tegola
tegola laterizio
Totali

