

- |                  |   |
|------------------|---|
| <b>Modul I</b>   | Do. 22. März<br><b>Einführung (Status quo mehrgeschossiger Holzbau)</b> |
| <b>Modul II</b>  | Do. 05. April<br><b>Ausschreibung/Kosten</b>                            |
| <b>Modul III</b> | Do. 19. April<br><b>Planungsprozesse</b>                                |
| <b>Modul IV</b>  | Do. 03. Mai<br><b>Brandschutz</b>                                       |
| <b>Modul V</b>   | Do. 24. Mai<br><b>Schallschutz</b>                                      |
| <b>Modul VI</b>  | Do. 07. Juni<br><b>Technische Gebäudeausstattung</b>                    |

## **Modul VI – Technische Gebäudeausstattung**

Wien, Do.07. Juni 2018

\_Daniela Koppelhuber, TU Graz, Institut für Baubetrieb und Bauwirtschaft

\_Christoph Urschler, TBH Ingenieur GmbH

\_Simon Speigner, sps-architekten

Dieses Modul wird unterstützt von



## **Modul VI – Technische Gebäudeausstattung**

# **Ausführung und Umsetzung anhand gebauter Beispiele**

\_Simon Speigner, sps-architekten

## INHALT

- Seniorenwohnhaus,  
Hallein
- Plusenergie-Bürogebäude  
und Kulturkraftwerk oh456,  
Thalgau
- Holzwohnbau Hummelkaserne,  
Graz
- Zusammenfassung

# SENIORENWOHNHAUS, HALLEIN



Bauherr:	Stadtgemeinde Hallein
Wettbewerb:	03.2008 bis 08.2008 (1. Preis)
Planung:	01.2009 bis 05.2013
Bauzeit:	03.2012 bis 10.2013
Baukosten Immobilien:	EUR 16,5 Mio.
Baukosten Mobilien:	EUR 3,2 Mio.
Bauplatzfläche:	8.224 m <sup>2</sup>
Überbaute Fläche:	2.093 m <sup>2</sup>
Bruttogeschossfläche:	10.218 m <sup>2</sup>
Nutzfläche:	8.513 m <sup>2</sup>
umbauter Raum ui:	2.665 m <sup>3</sup>
umbauter Raum oi:	31.676 m <sup>3</sup>
Anzahl Zimmer/Betten:	128 Einzelzimmer, 8 Doppelzimmer



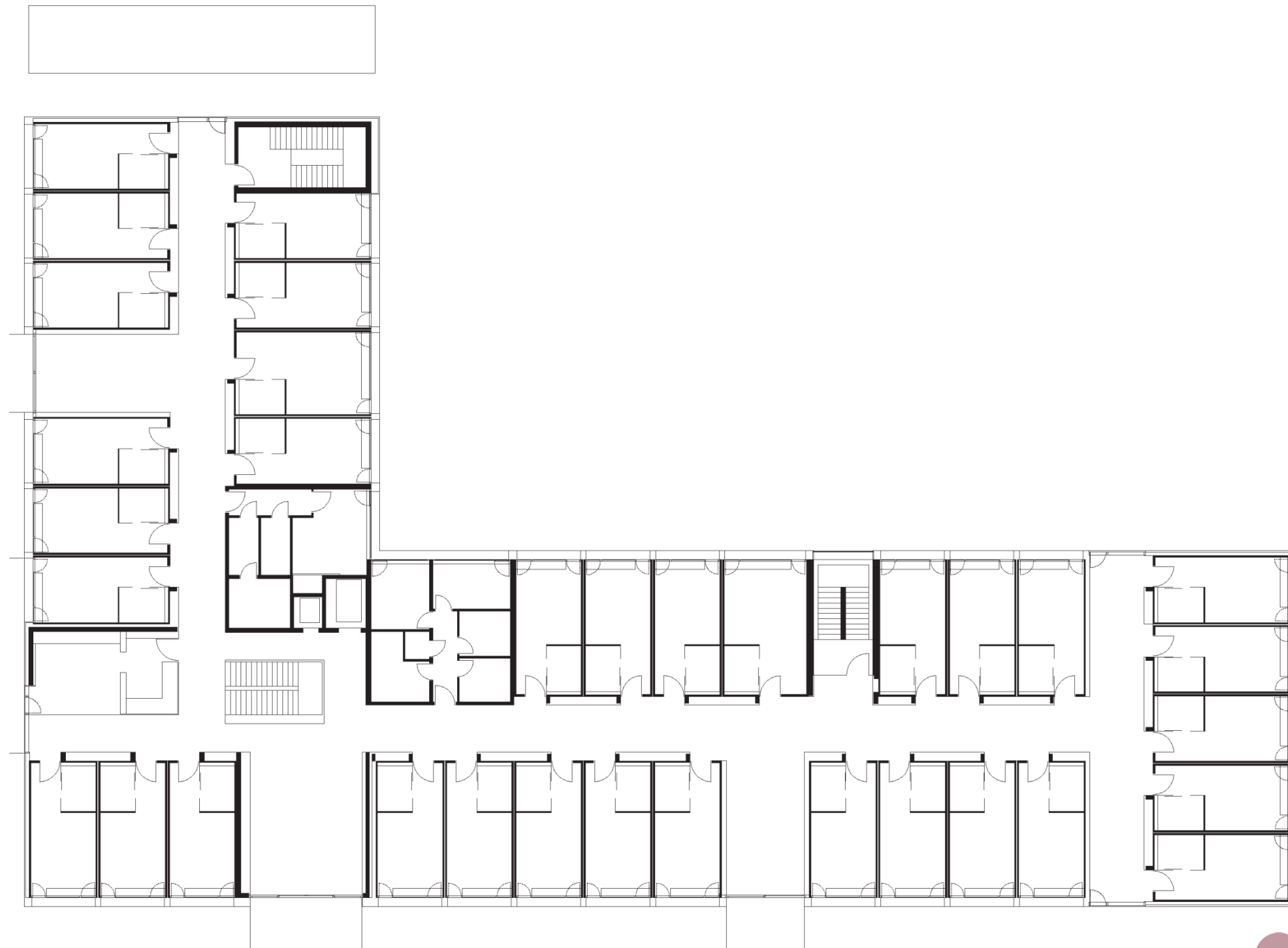



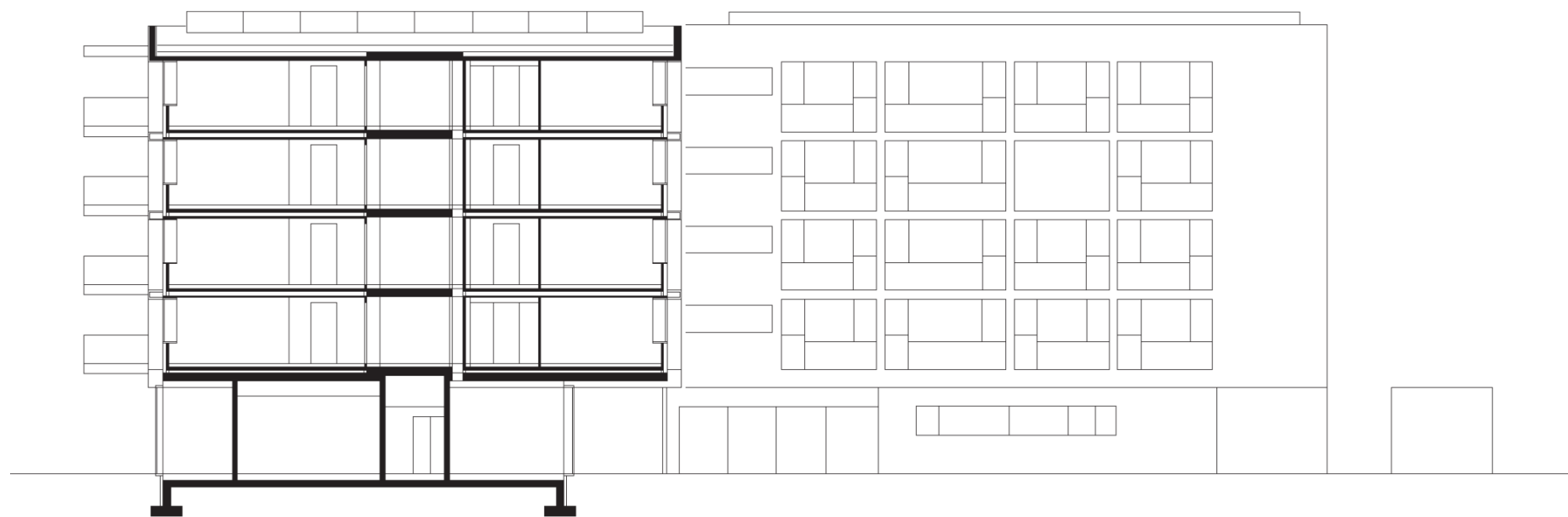

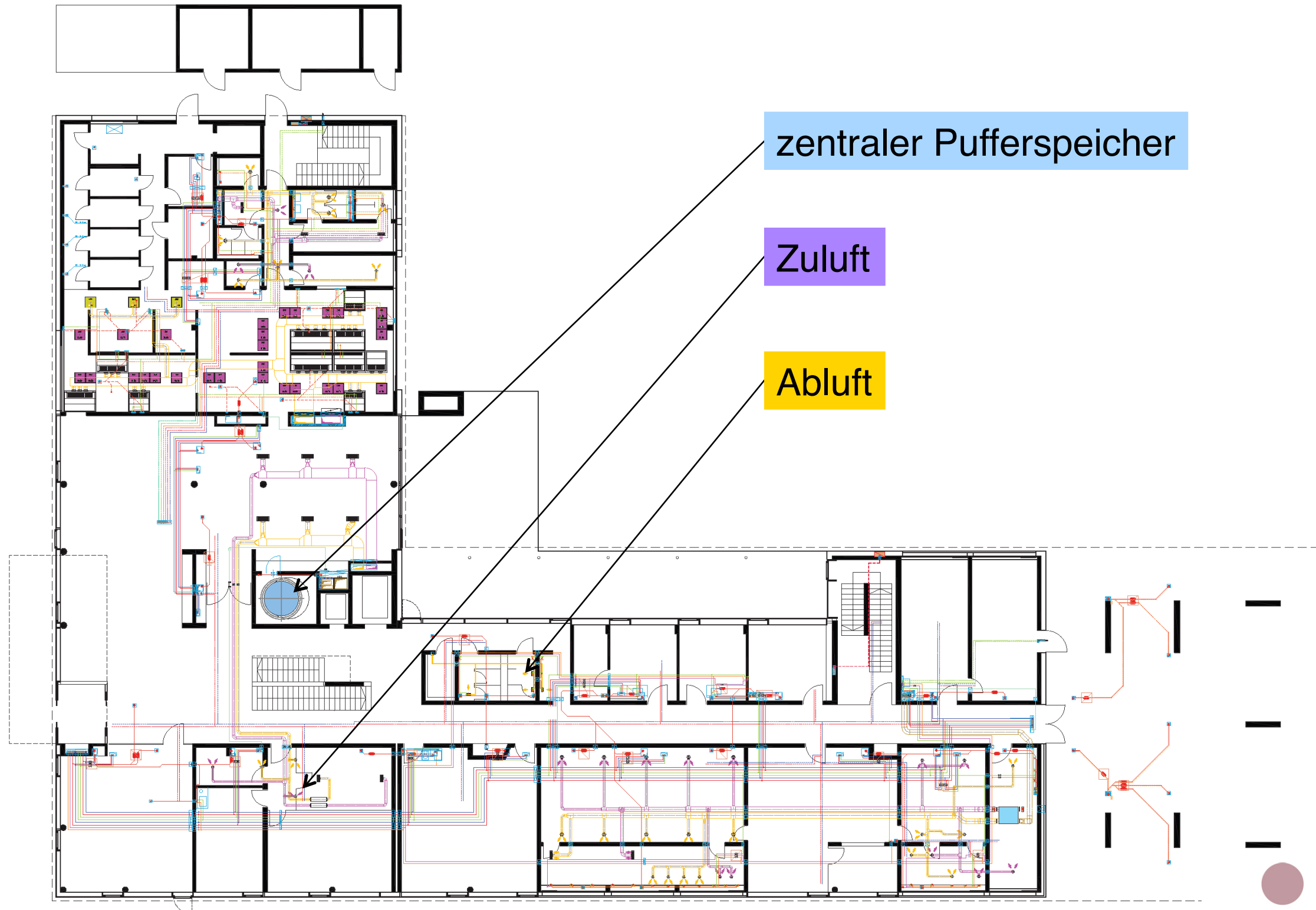

sps+architekten

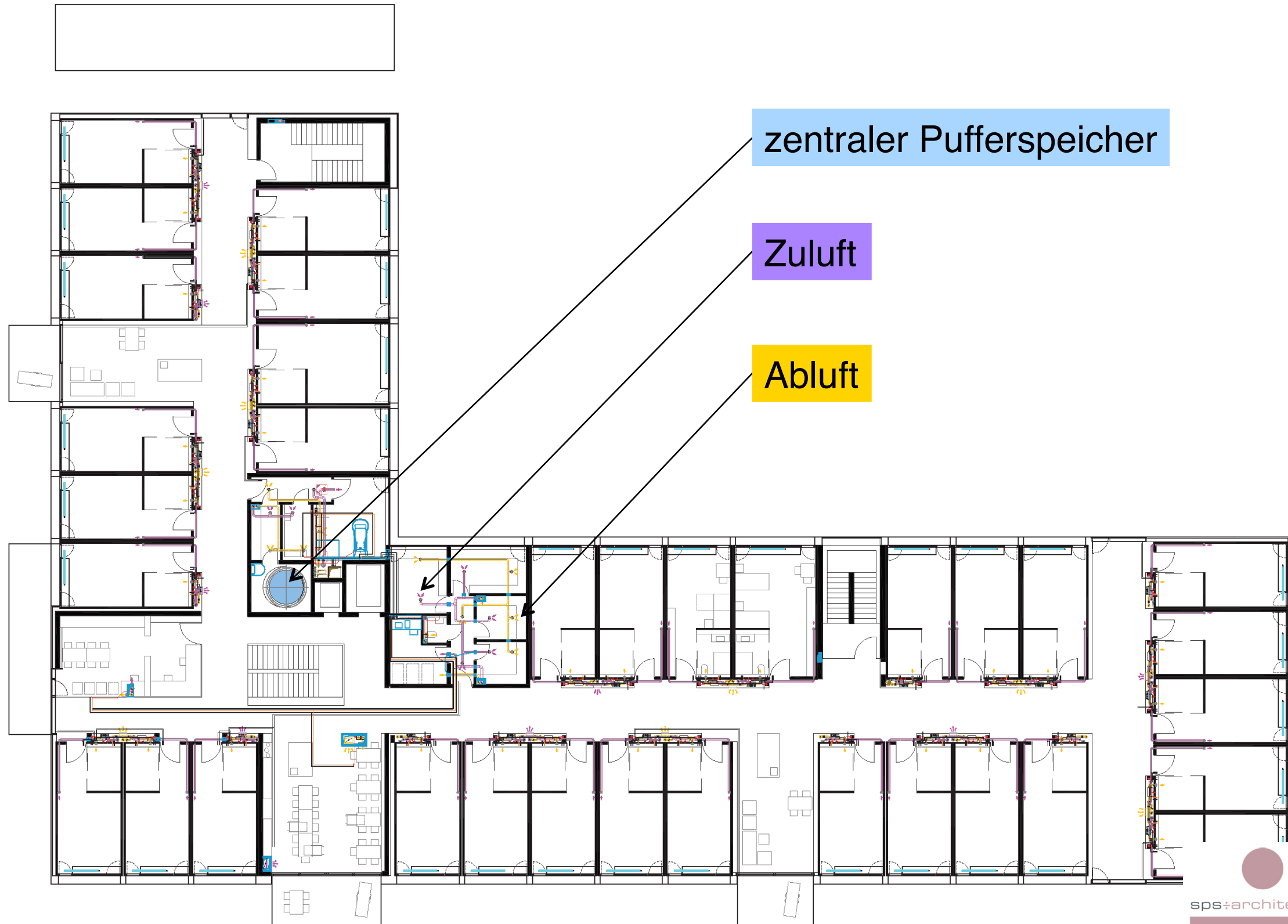

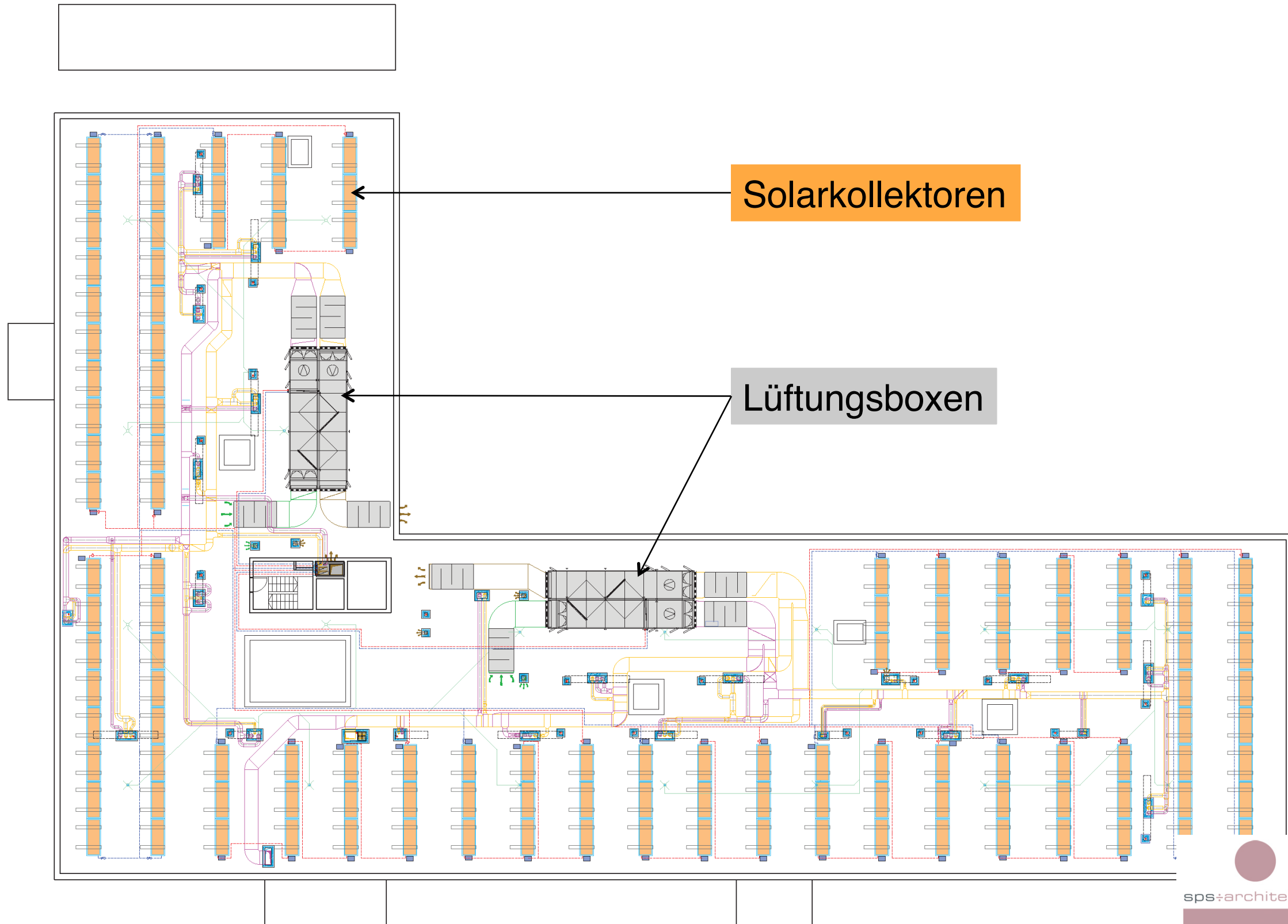

### SCHNITT A-A

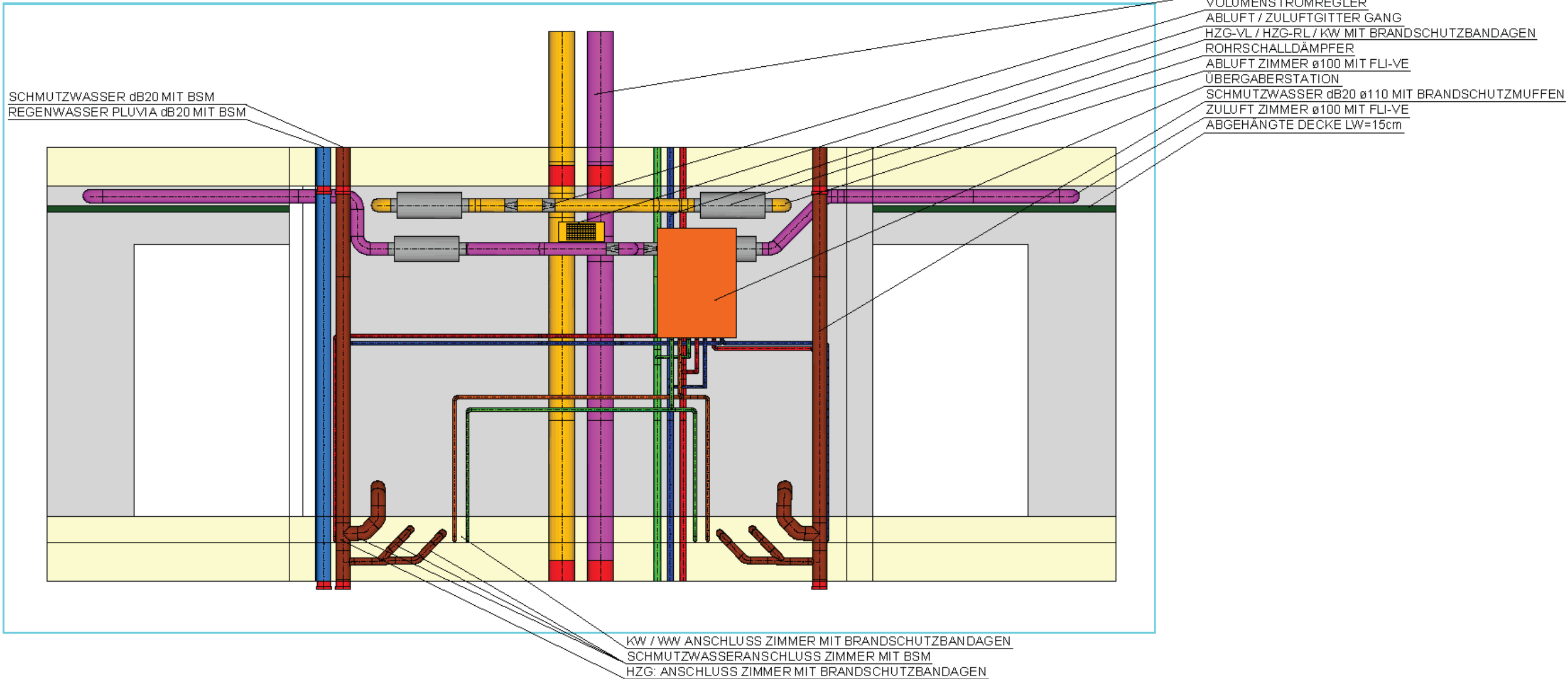

### GRUNDRISS

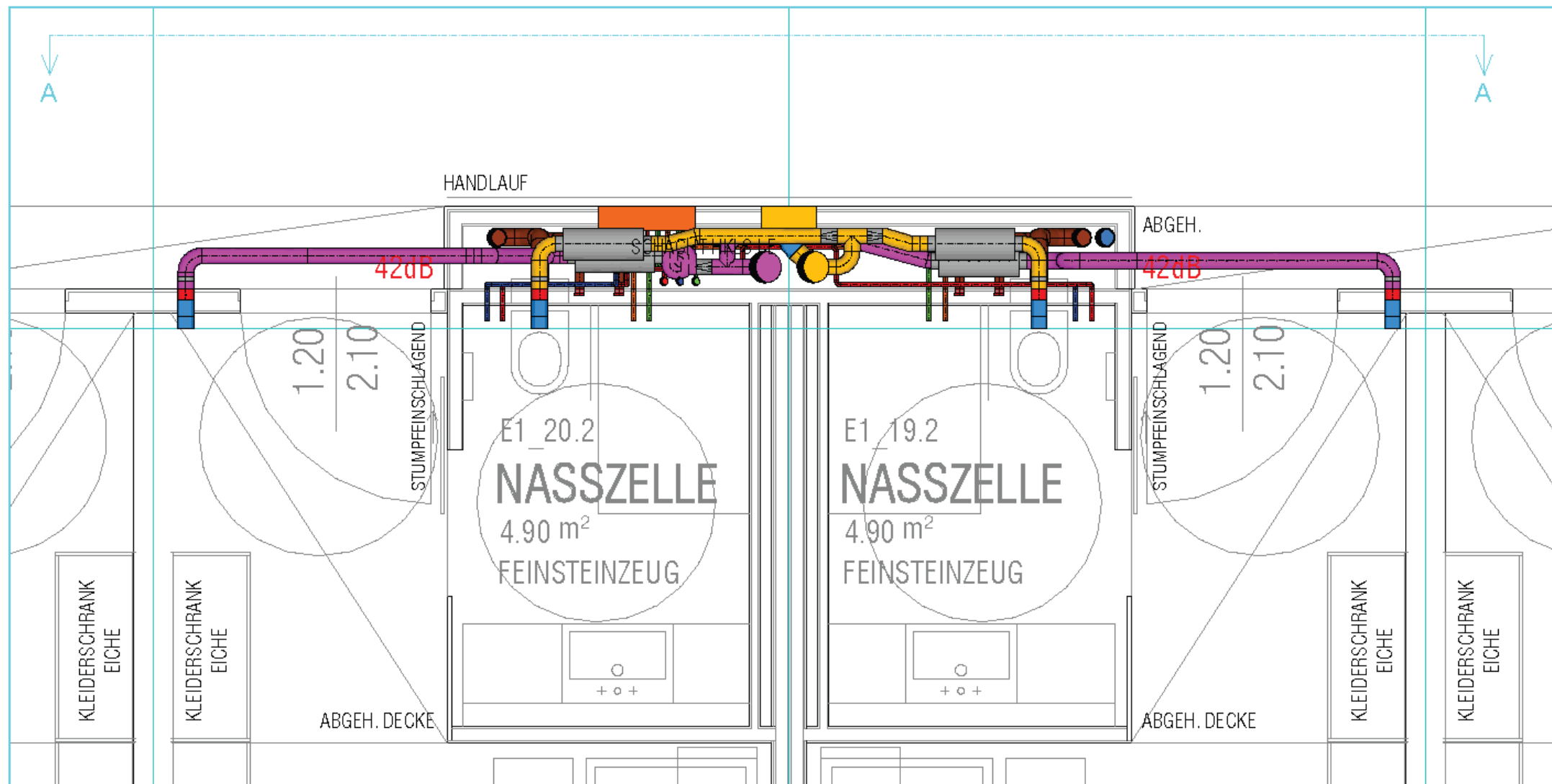

### ISO - ANSICHT

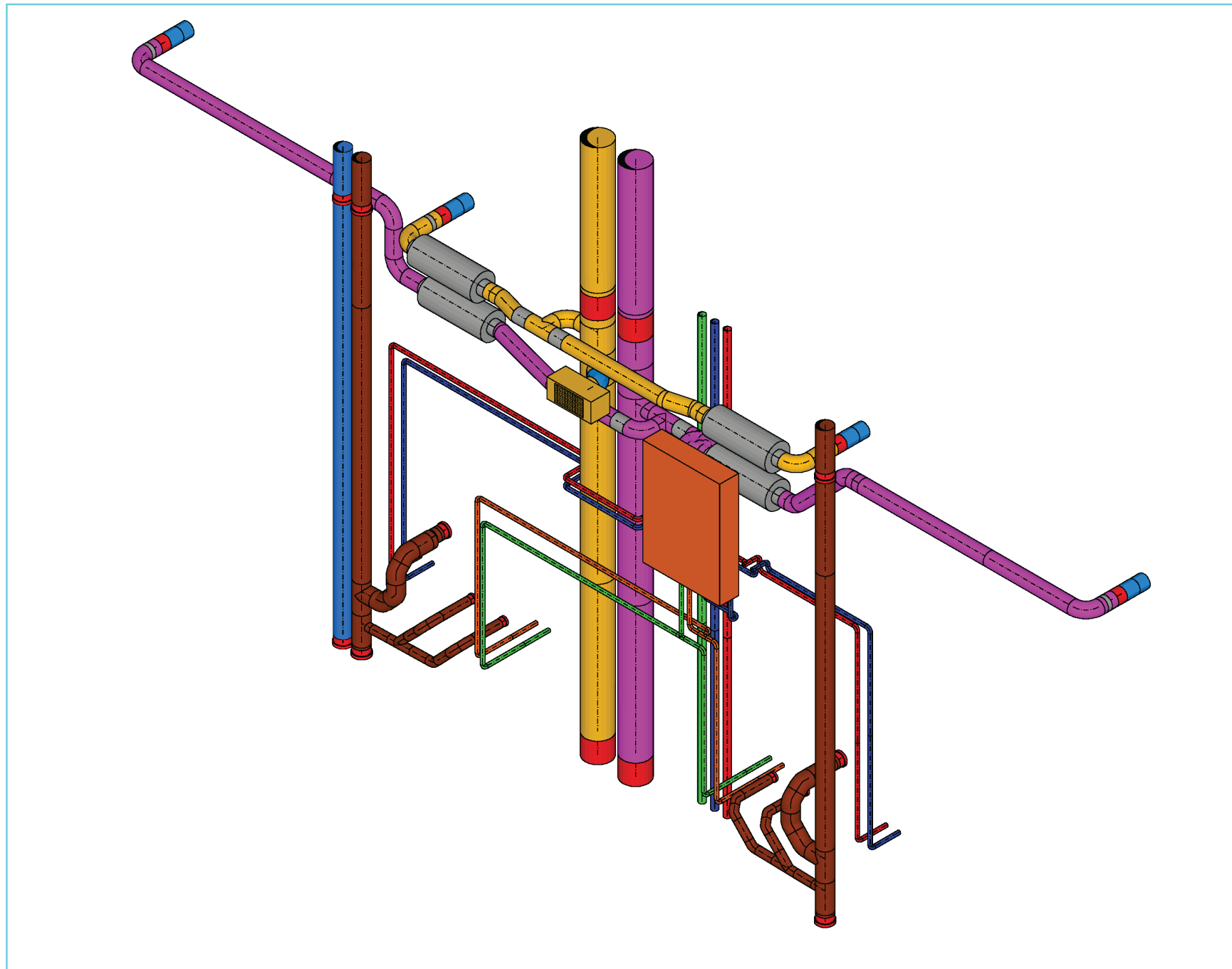





# PLUSENERGIE-BÜROGEBÄUDE UND KULTURKRAFTWERK OH456, THALGAU



Bauherr:	sps-architekten zt gmbh & co kg, Thalgau
Planung:	01.2008 bis 12.2012
Bauzeit:	09.2012 bis 01.2014
Bauplatzfläche:	2.455 m <sup>2</sup>
überbaute Fläche:	455 m <sup>2</sup>
Bruttogeschossfläche:	1.569 m <sup>2</sup>
Nutzfläche gesamt:	1.329 m <sup>2</sup> (inkl. Keller)
umbauter Raum ui:	588 m <sup>3</sup>
umbauter Raum oi:	4.254 m <sup>3</sup>

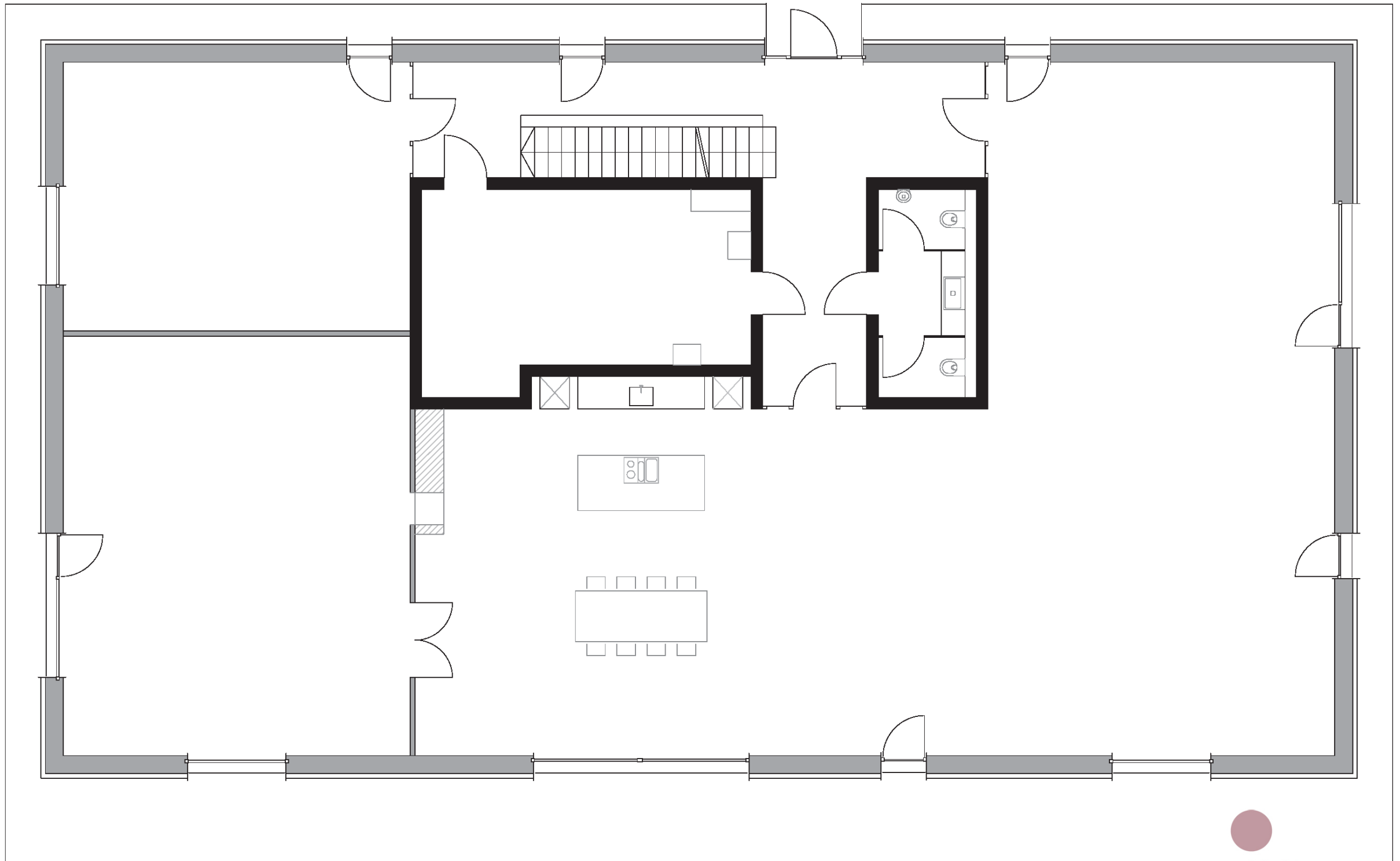

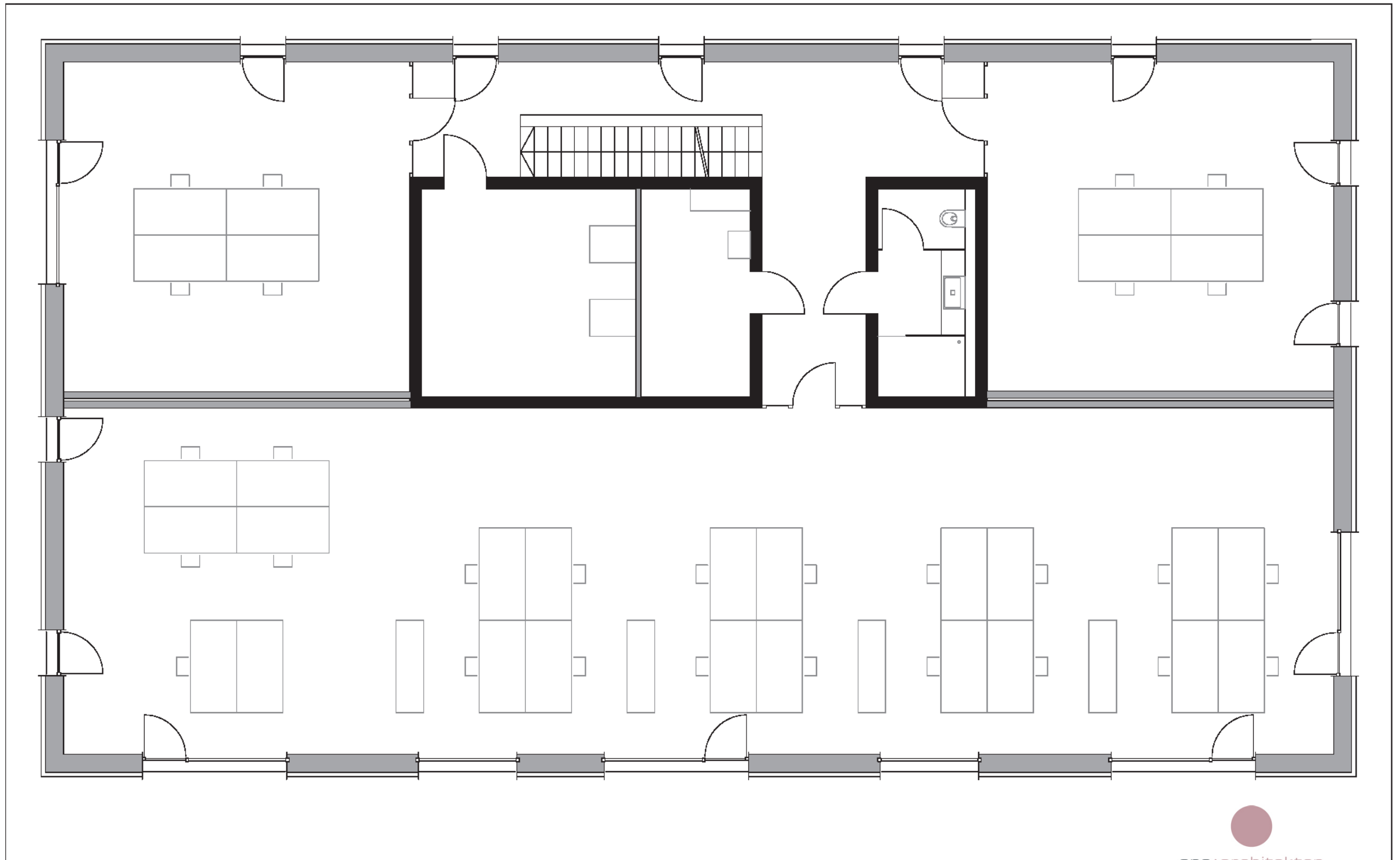

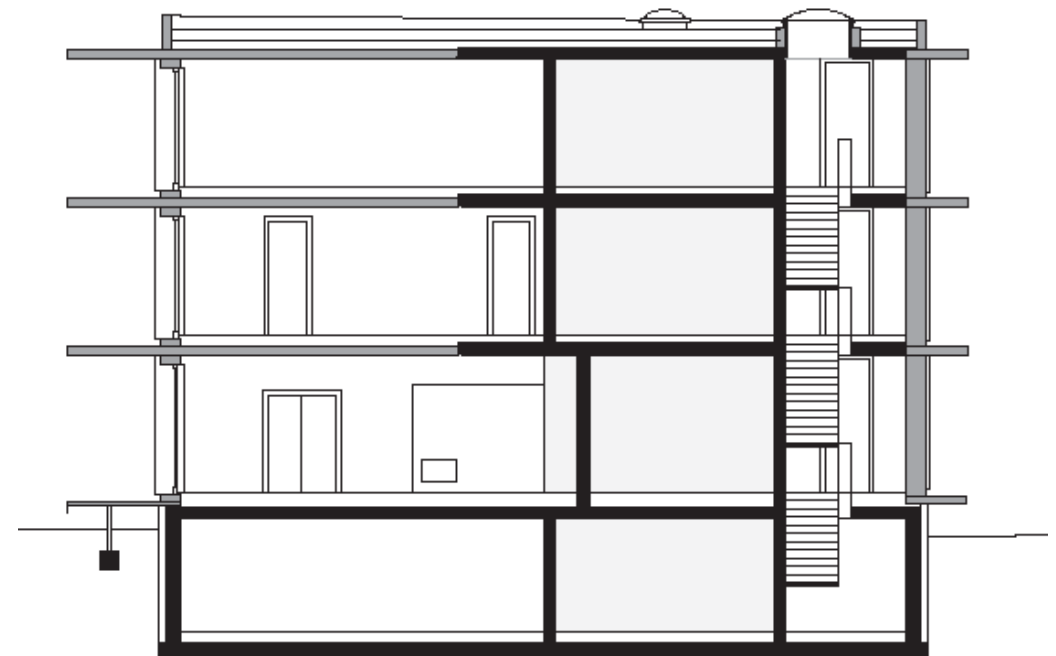

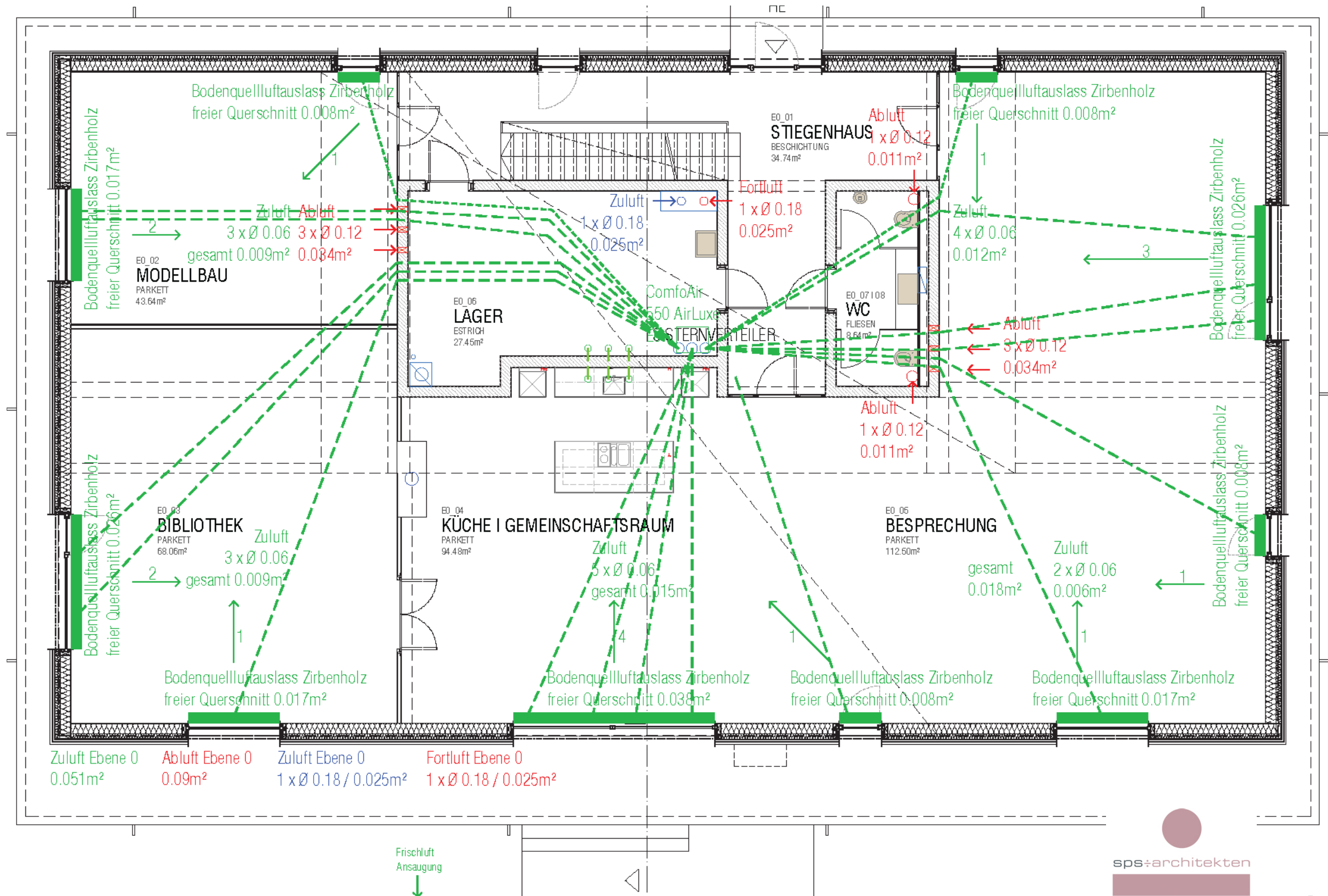

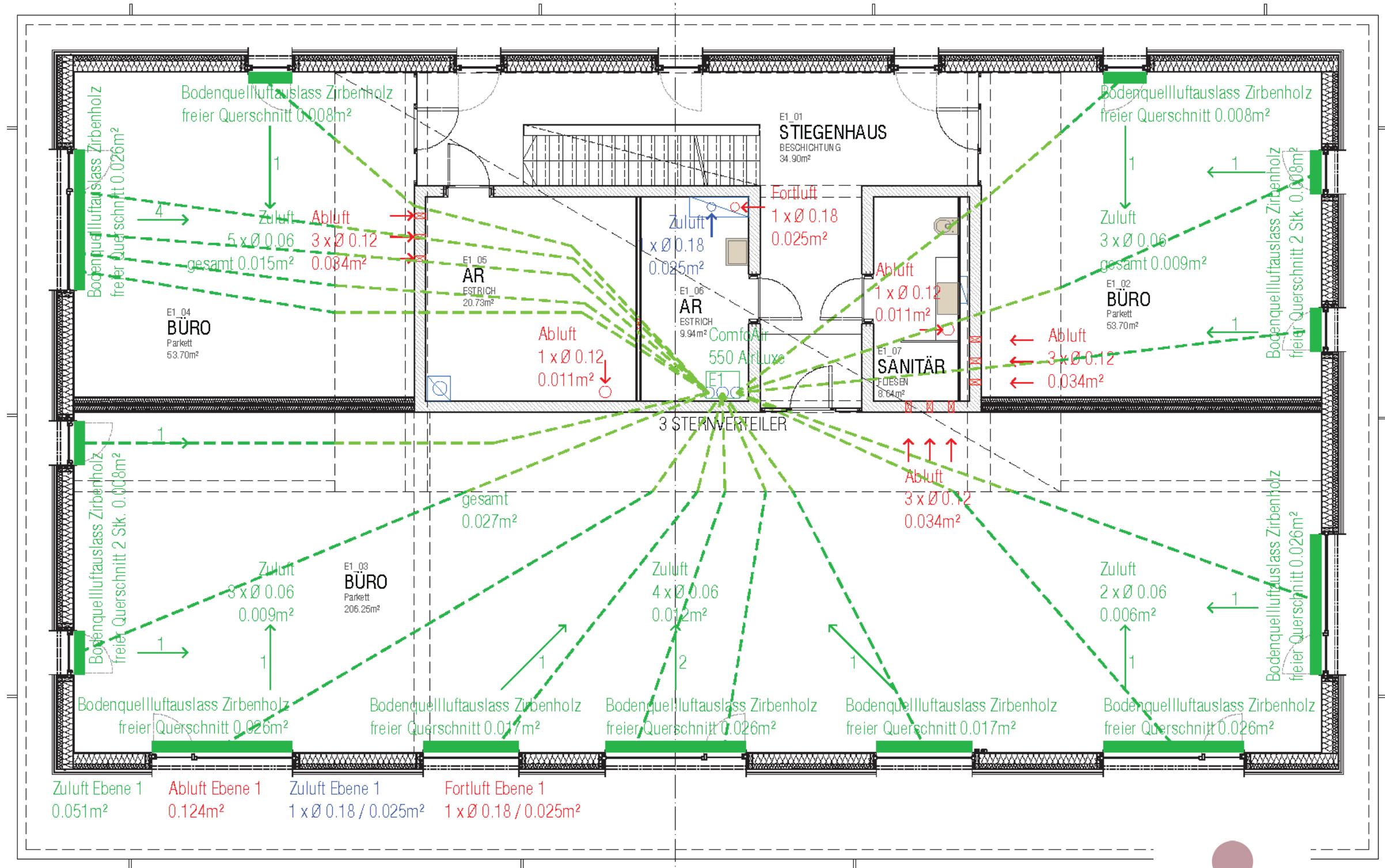

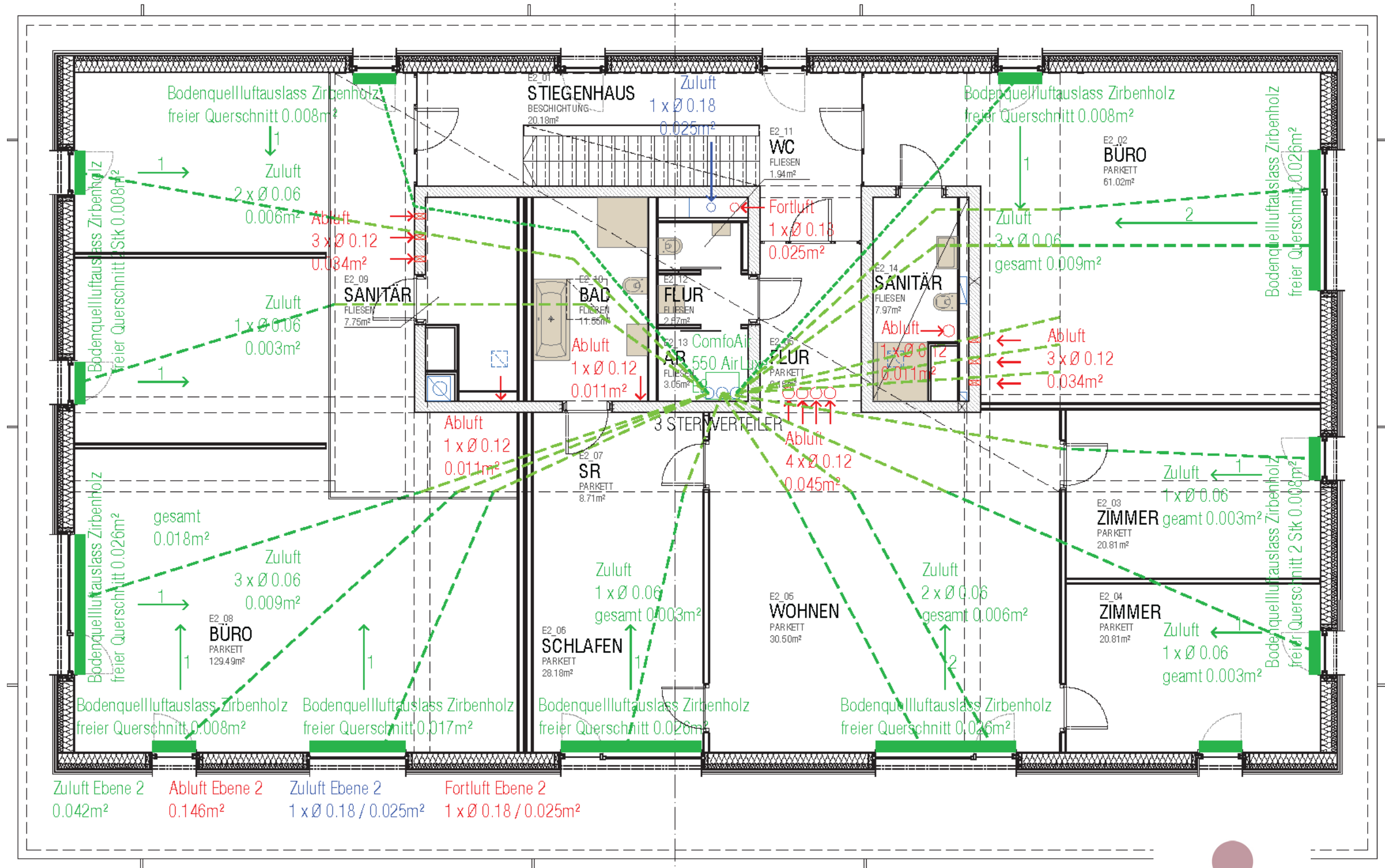



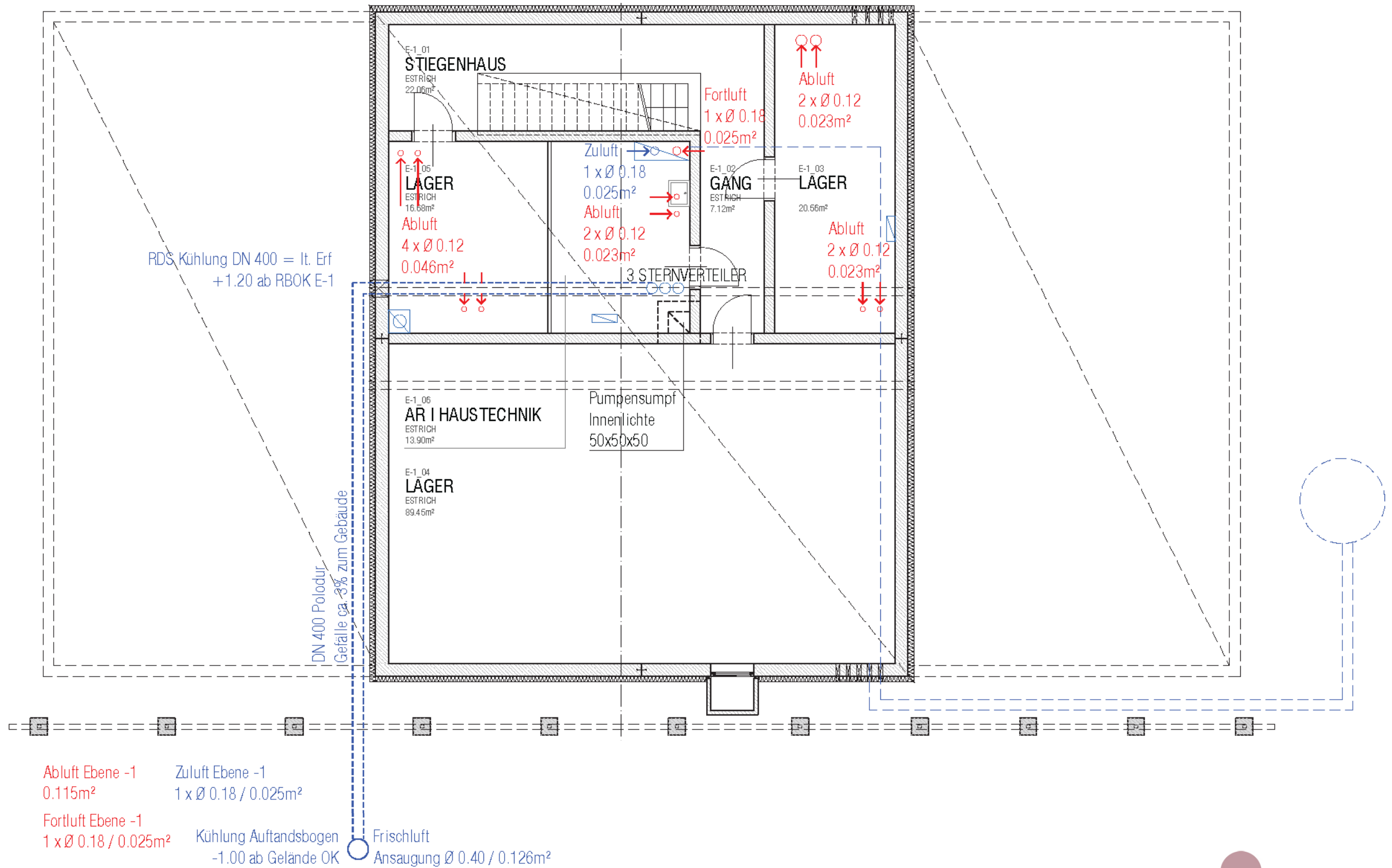

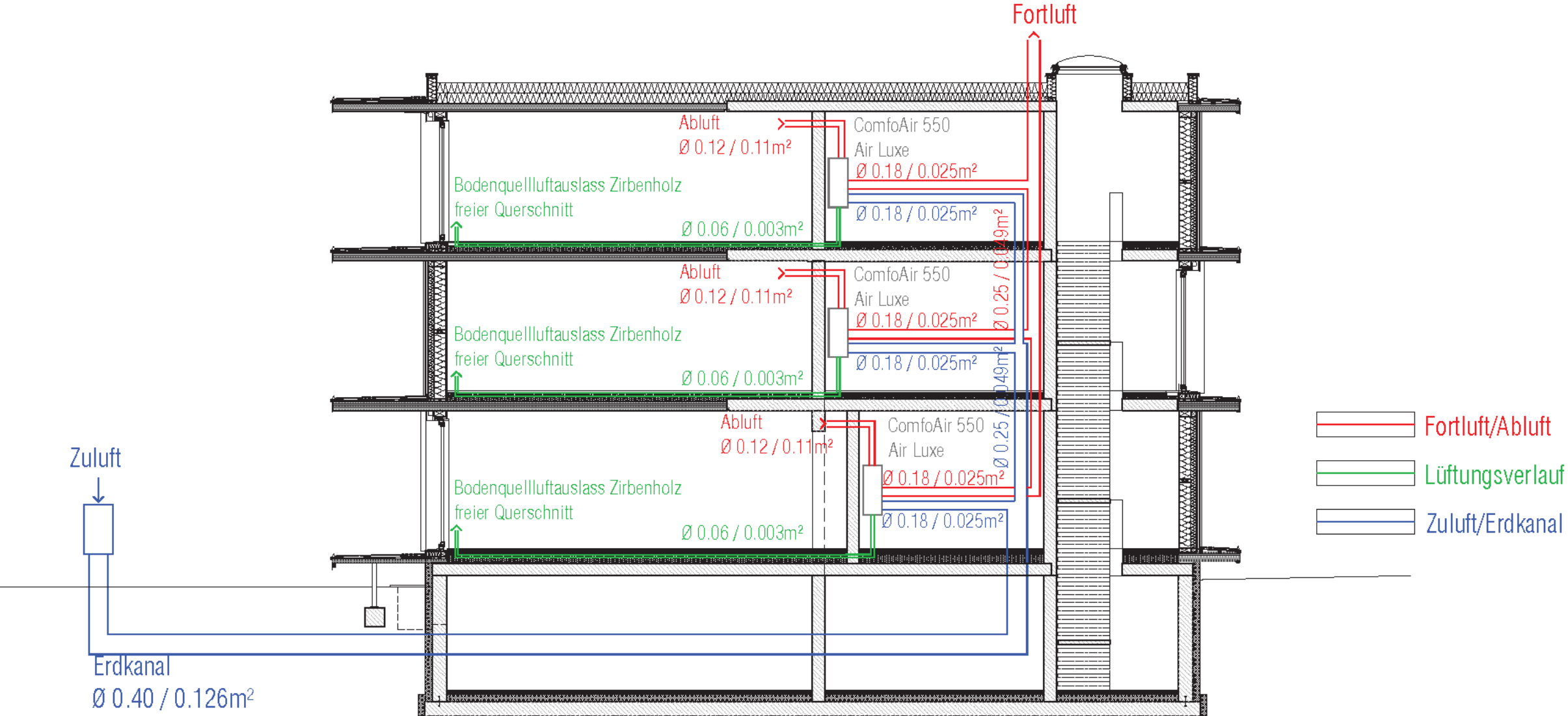

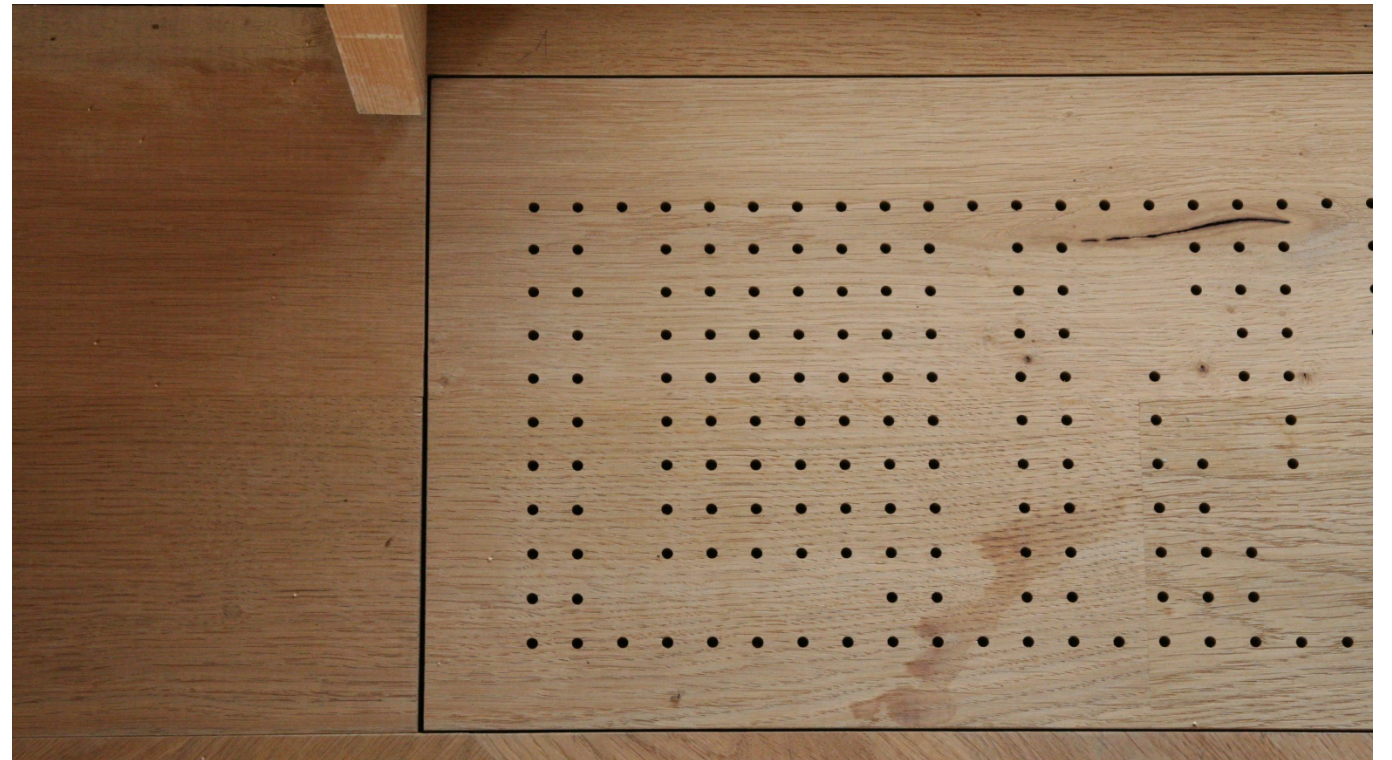

# HOLZWOHNBAU HUMMELKASERNE, GRAZ



Bauherr:	ENW – Gemeinnützige Wohnungsgesellschaft mbH, Graz
Wettbewerb:	08.2012 bis 02.2013 (1. Preis)
Planung:	09.2013 bis 12.2014
Bauzeit:	01.2015 bis 07.2016
Baukosten:	EUR 9,8 Mio.
Grundstücksfläche:	11.021 m <sup>2</sup>
Bruttogeschossfläche:	8.003 m <sup>2</sup>
Nutzfläche:	6.600 m <sup>2</sup>
umbauter Raum:	22.065 m <sup>3</sup>
Anzahl der Wohnungen:	92

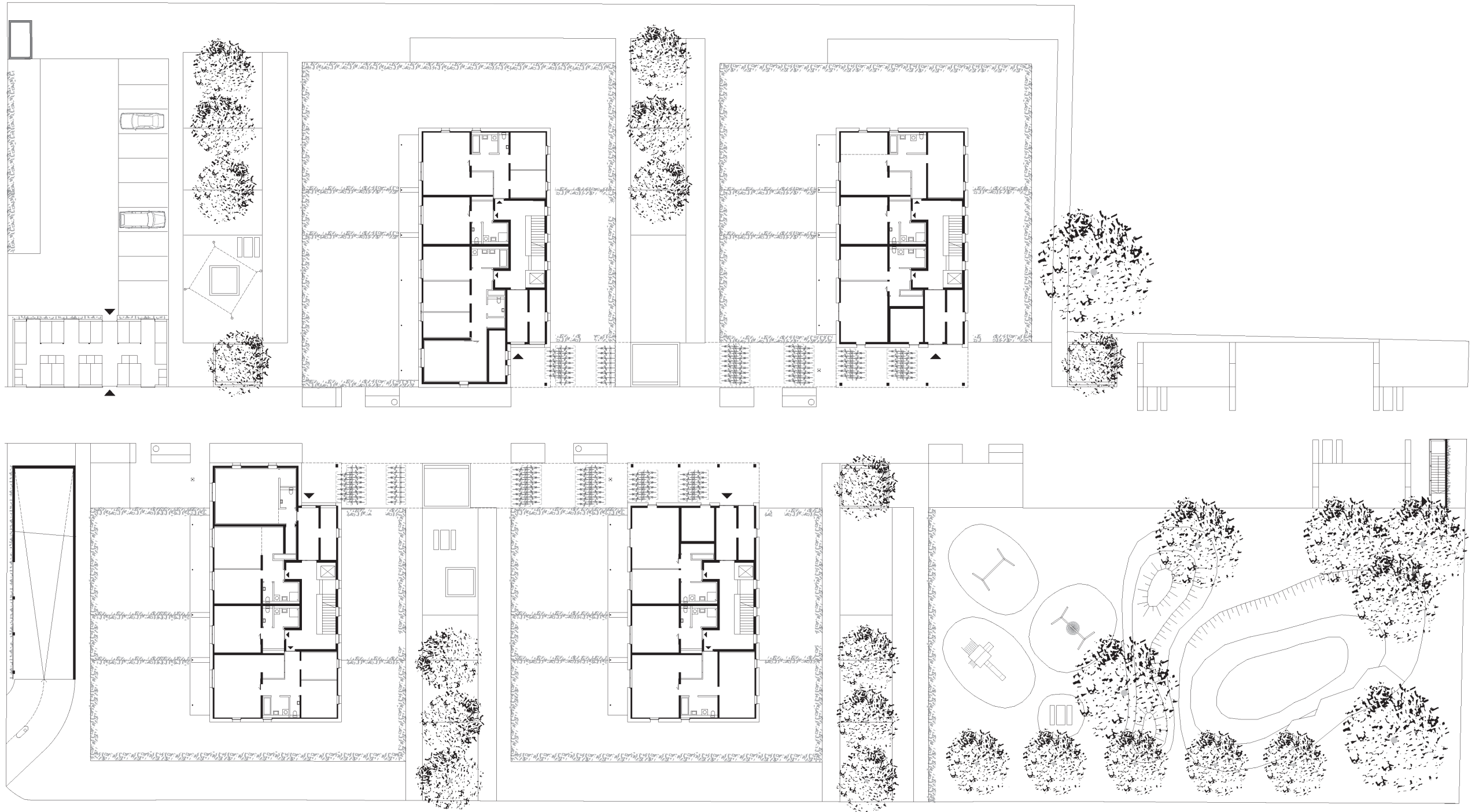

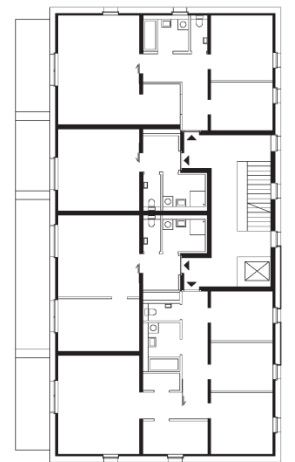
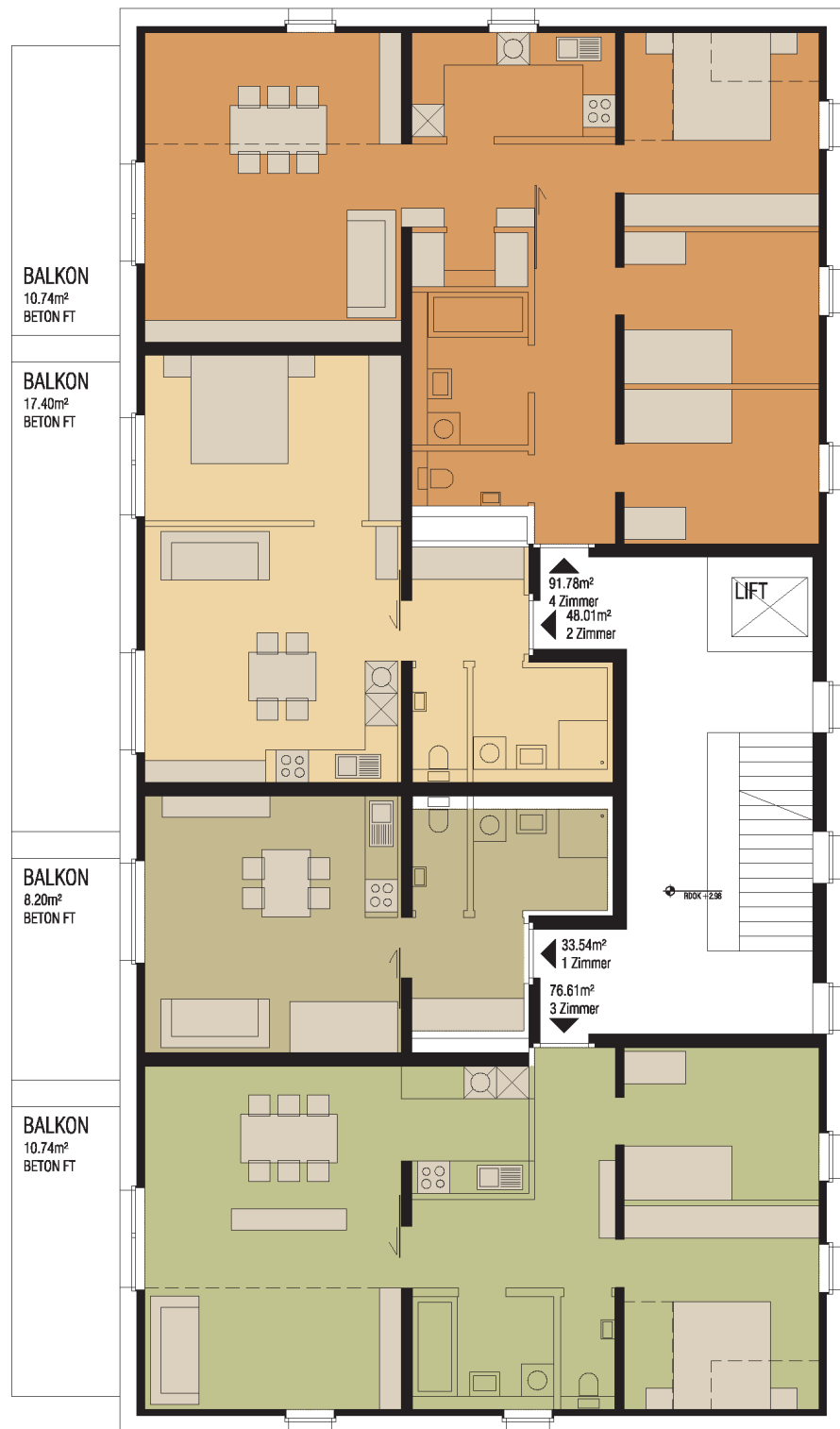

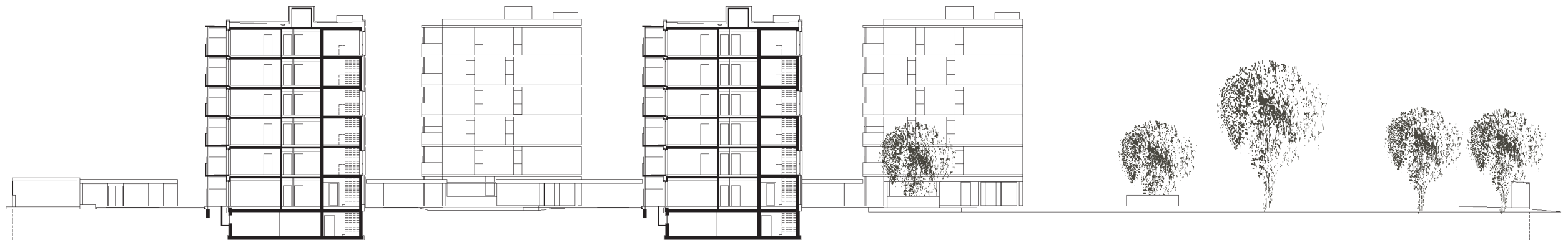



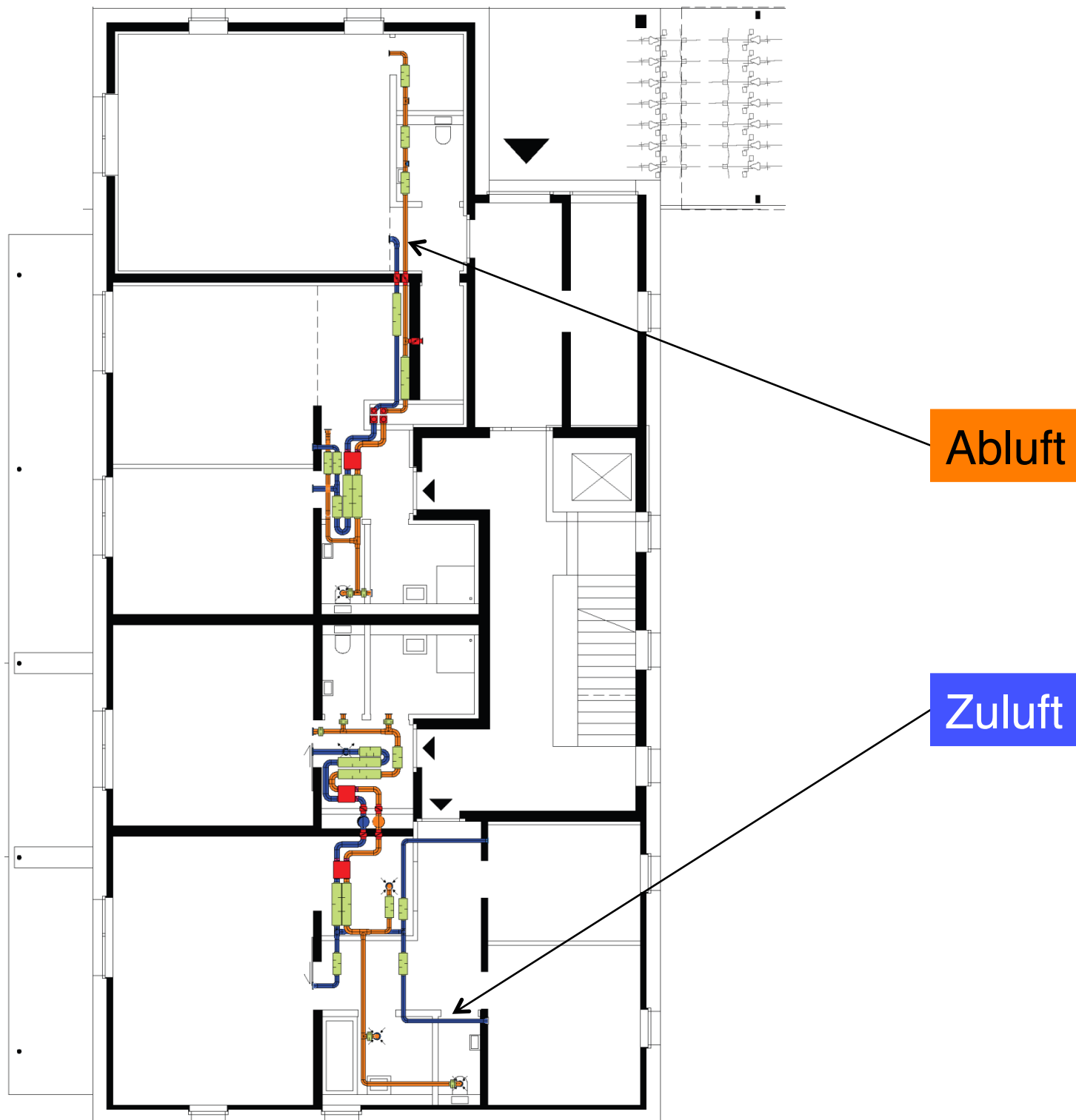

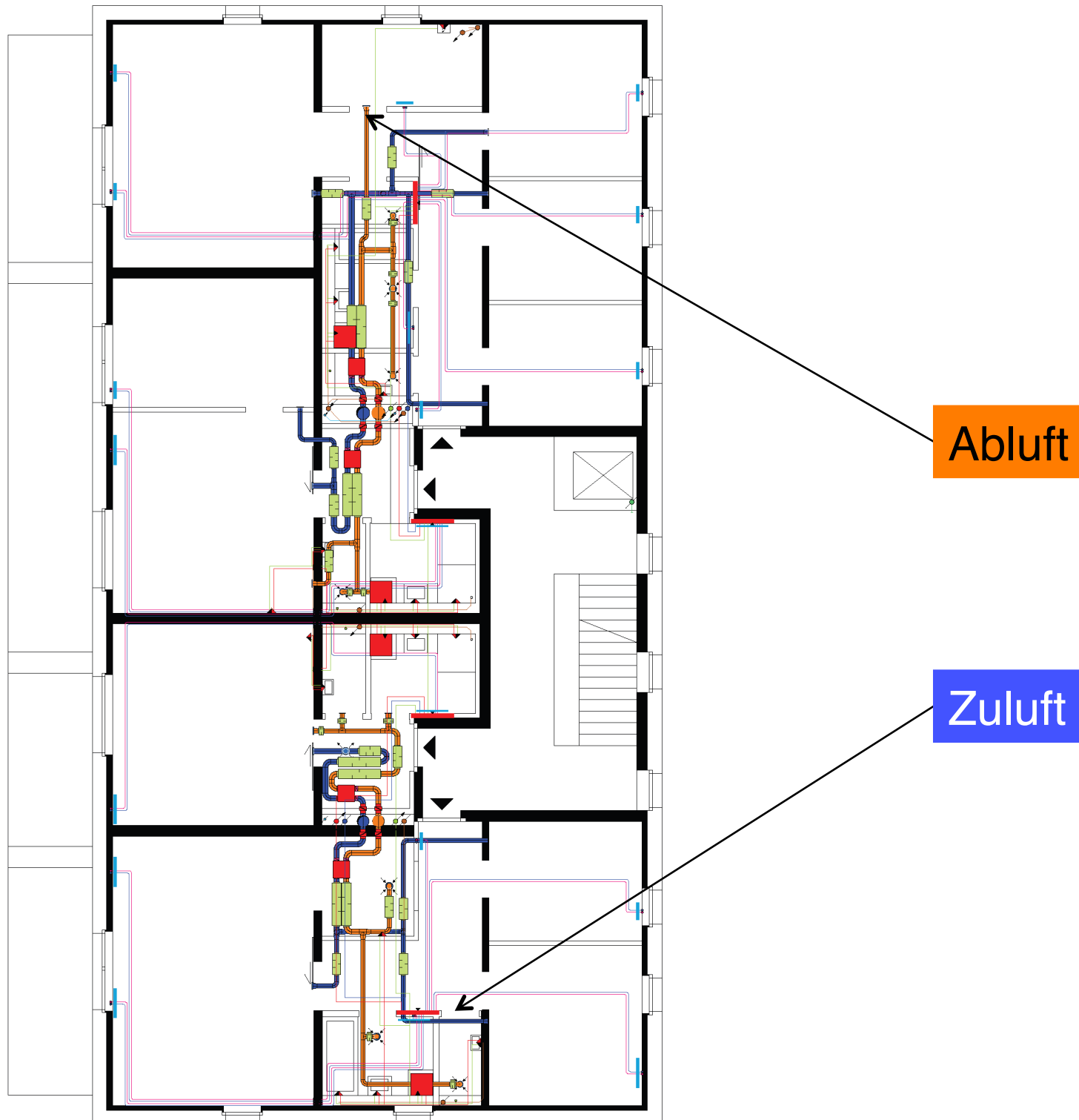

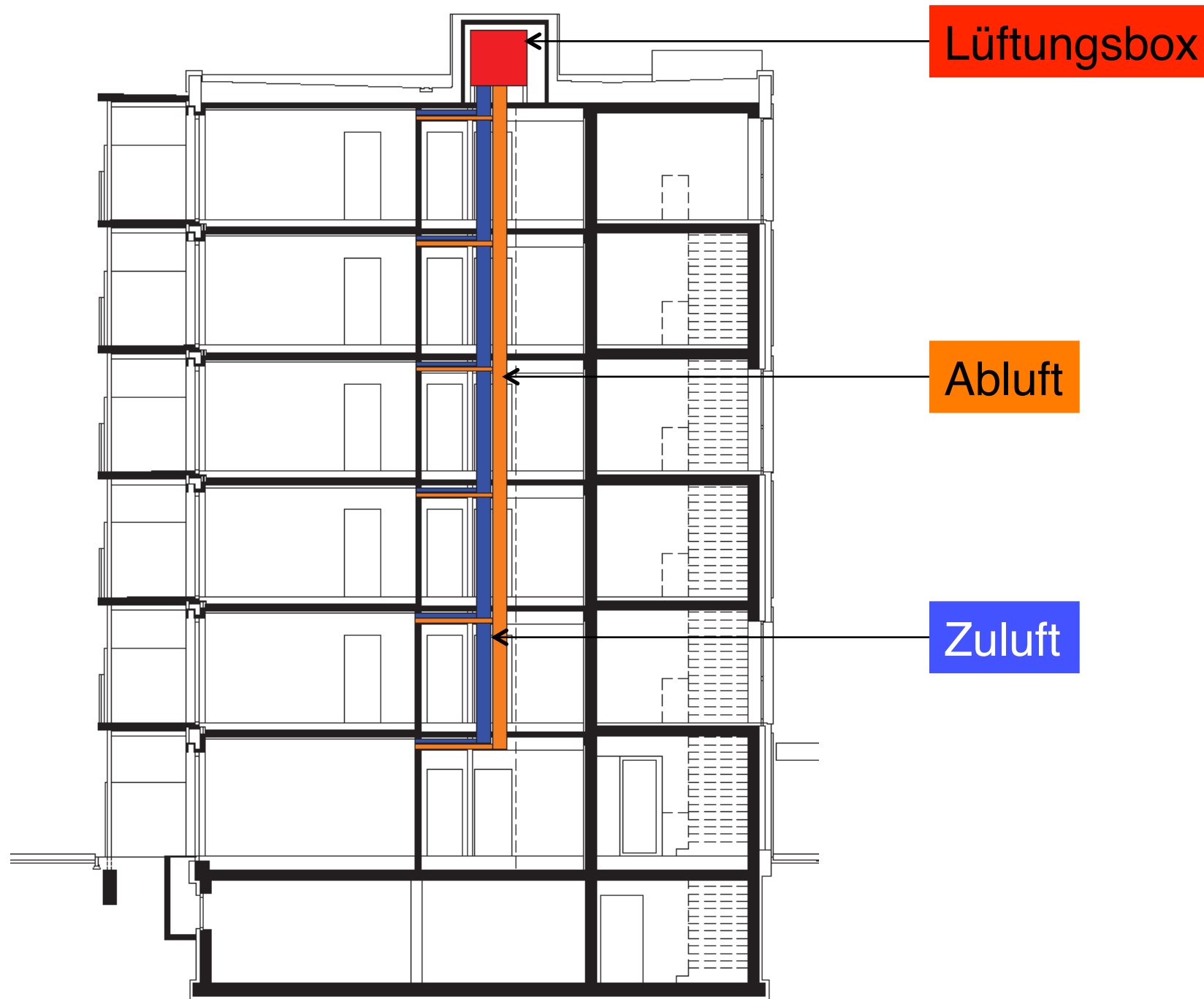

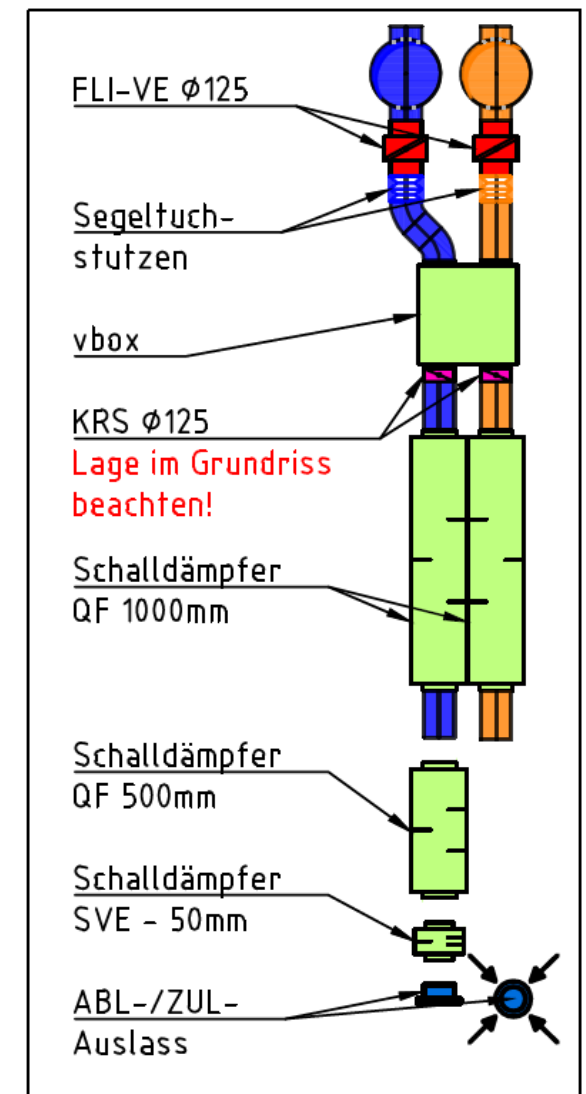
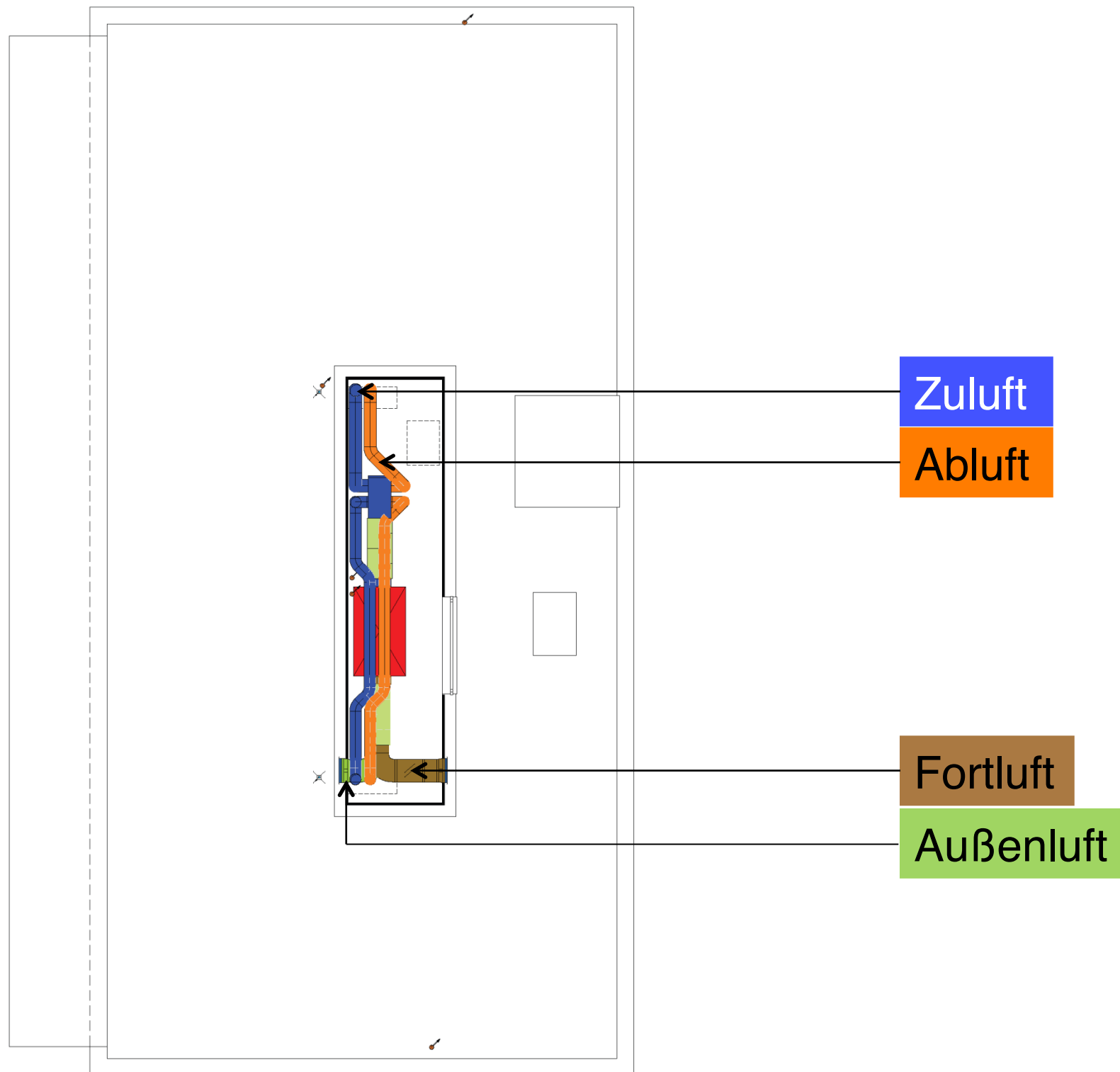



## ZUSAMMENFASSUNG

- „less is more“
- reduzierte Haustechnik ohne Komforteinbusse
- Vorfertigungsgrad erhöhen
- Revisionsmöglichkeiten – Tauschbarkeit
- Vereinfachung
- keine wassergeführten Systeme
- einfache Leitungsführung

## DO's and Don'ts

- klare Konzeptabstimmung in der frühen Entwurfsphase
- Entwurf hinsichtlich Strangführung optimieren
- große Durchbrüche mit dem Statiker optimieren
- horizontale und vertikale Strangführung in Abstimmung mit Haus- und Elektrotechnik koordinieren
- 3-D Planung
- Kreuzungen fixieren
- Planung weitestgehend finalisieren um später aufwendige Umplanungen zu vermeiden
- Vorfertigungsgrad auch in der TGA erhöhen
- schlankes Brandschutzkonzept
- „less is more!“ – Betriebskosten später optimieren



Passivreihenhaus oh123, Thalgau (2002)



Seniorenwohnhaus, Hallein (2013)



Hummelkaserne, Graz (2016)



LKH Graz Süd-West, Süd (2018)



Samer Mösl, Salzburg (2006)



Bürogebäude oh456, Thalgau (2014)



Agrarzentrum, Maishofen (2017)



Wildgarten, Wien (in Planung)



Sportpark Lissfeld, Linz (2010)



ZIS, St. Johann im Pongau (2015)



Hotel Heffterhof, Salzburg (2017)



Kapelle der Barmherzigkeit, Ried am Wolfgangsee (2018)

sps+architekten

